

BULLETIN FOR THE HISTORY OF CHEMISTRY

Division of the History of Chemistry of the American Chemical Society

NUMBER 10

FALL 1991

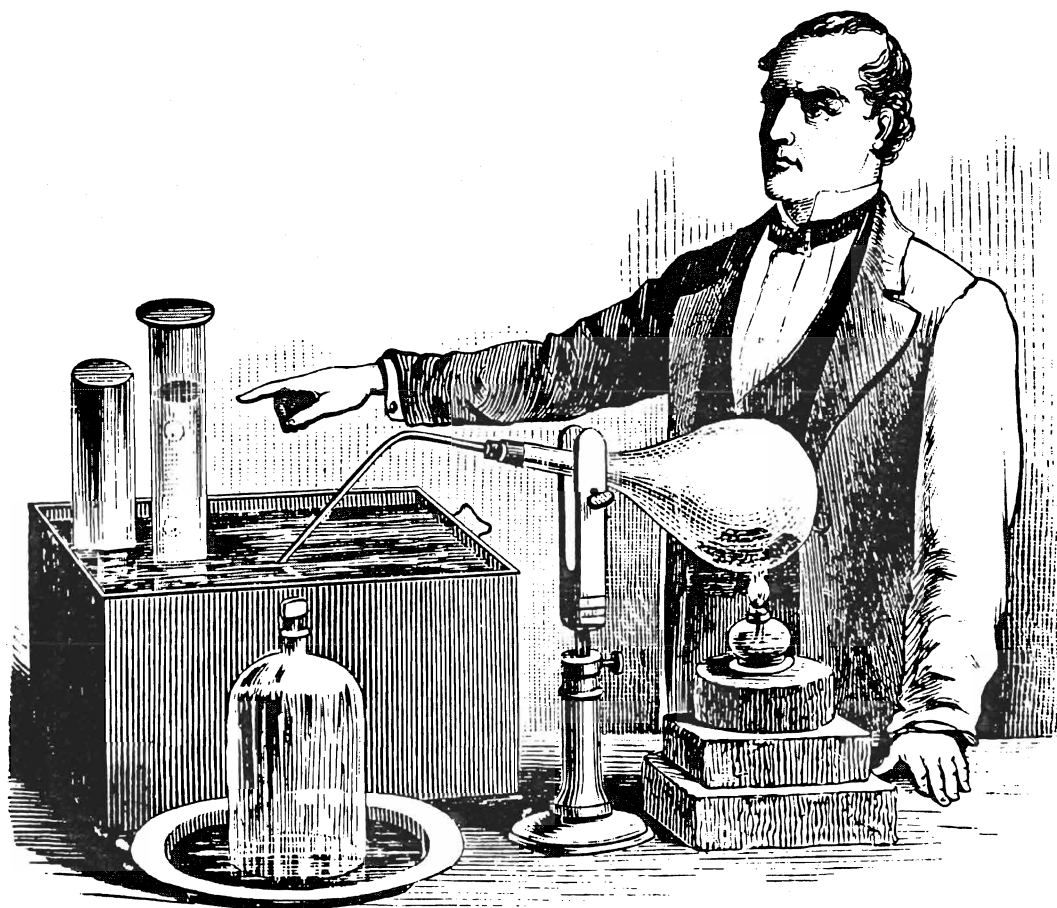

The Art of the Chemical Demonstration

BULLETIN FOR THE HISTORY OF CHEMISTRY, NO. 10, 1991

Editor William B. Jensen
 Associate Editor James J. Bohning
 Associate Editor Alan J. Roche
 Editorial Assistant I Kathy Orchin
 Editorial Assistant II Elaine Seliskar

The BULLETIN FOR THE HISTORY OF CHEMISTRY (ISSN 1053-4385) is published by the Division of the History of Chemistry of the American Chemical Society in collaboration with the Oesper Collection in the History of Chemistry of the University of Cincinnati. All changes of address should be sent to the current Treasurer of the Division.

EDITORIAL BOARD

Jeffrey L. Sturchio
 Merck & Co., Inc.
Derek A. Davenport
 Department of Chemistry, Purdue University
O. Theodor Benfey
 The Beckman Center for the History of Chemistry

CORRESPONDING EDITORS

Peter J. T. Morris
 The Science Museum, London, England
Yasu Furukawa
 Tokyo Denki University, Tokyo, Japan

The Cover...

This issue shows a woodcut from the 1887 edition of Joel Dorman Steele's *Popular Chemistry* of a lecturer demonstrating the preparation of oxygen gas to a class of high school students. The history and iconography of lecture demonstrations are featured in this issue in the article by Jensen in honor of the career of Hubert Newcombe Alyea.

All illustrations unless otherwise indicated are from the Oesper Collection in the History of Chemistry of the University of Cincinnati.

CONTENTS

To Demonstrate the Truths of "Chymistry" <i>by William B. Jensen</i> An historical and pictorial celebration of the art of the lecture demonstration in honor of Dr. Hubert Alyea	3
Henry Marshall Leicester <i>by George B. Kauffman</i> A tribute to one of this century's foremost chemical historians	15
Some Edgar Fahs Smith Memorabilia <i>by William D. Williams</i> Among other things, the doyen of American chemical historians liked cheap adventure novels and amateur theatricals	21
The History of Food Colorants Before Aniline Dyes <i>by Harold T. McKone</i> When inorganic rather than organic chemistry ruled both the artist's palette and the gourmet's palate	25
Early Industrial pH Measurement and Control <i>by John T. Stock</i> Some insights into automated pH control before the advent of the pH meter	31
Old Chemistries <i>by William D. Williams</i> Celebrating the bicentennial of James Tytler's <i>System of Chemistry</i>	34
Book Notes A new history of chemistry, biographies of Robert Robinson, Michael Faraday, Lawrence Bragg and Carl Djerassi, a reproduction of a 16th century mining classic, a new collection from the Deutsches Museum, and a history of the American synthetic rubber project	39
Letters	45
Divisional News	
From the Chair	45
Events of Interest	46
Future Meetings	46
1992 Officers Directory	47
Future Issues A preview of our special Faraday issue	47

TO DEMONSTRATE THE TRUTHS OF "CHYMISTRY"

An Historical and Pictorial Celebration of the Art of the Lecture Demonstration in Honor of Dr. Hubert Alyea

William B. Jensen, University of Cincinnati

The name of Hubert Newcombe Alyea is virtually synonymous with the term chemical demonstration and is known to every chemical educator of this generation. He has delighted countless audiences with his lectures and has enriched the chemical demonstration literature with his series of TOPS demonstrations and the Alyea projector. The following paper is based on a lecture entitled "Chemical Demonstrations BA (Before Alyea)", given at a symposium in Dr. Alyea's honor sponsored by the Division of Chemical Education at the 197th National ACS Meeting in Dallas, Texas, on 11 April 1989 (1).

The origins and use of lecture demonstrations in the teaching of chemistry are essentially coextensive with the origins of academic chemistry itself, and the origins of the latter, as historians have begun to realize, are in many ways the accidental side-effect of the activities of the 16th century Swiss-German iatrochemist, Philippus Aureolus Theophrastus Bombastus von Hohenheim (1493-1541), better known as Paracelsus (figure 1). Usually presented as a transitional figure, wedged between the age of alchemy and the phlogiston period in histories of chemistry, Paracelsus is generally credited with having deflected the activities of chemists from the pursuit of the transmutation of metals and the elixir of life into the development of chemical models of the human body and disease and the chemical preparation of drugs and medicines. Though a modern chemist would probably consider iatrochemical theories of physiology and materia medica, which were heavily tinged with mysticism and astrology, as little improvement over their alchemical predecessors, the importance of the iatrochemical movement for modern chemistry lies in the fact that, by fixing the medical community on chemical models of the human body and drug action, it inserted the wedge whereby chemistry gradually entered the traditional university curriculum under the guise of introductory service courses taught to



Figure 1. Philippus Aureolus Theophrastus Bombastus von Hohenheim, better known as Paracelsus (1493-1541).

students of medicine and pharmacy (2).

By the beginning of the 17th century, a small, but increasing, number of medical schools were employing professors of medicine with explicit chemical interests (Table 1), such as Andreas Libavius (1540-1616) at Rothenburg (1592) or Daniel Sennert (1572-1637) at Wittenberg (1602), and in 1609 Johann Hartmann (1568-1631) was actually appointed to an explicit chair of "iatrochemistry" at the medical school in Marburg. In the case of pharmaceutical chemistry, the appointment of "Demonstrators" in chemistry in connection with famous botanical or drug gardens became increasingly common, including that of William Davisson (1593-1669) at the Jardin du Roi in 1648 and Charles Louis van Maets at Leyden in 1669. Indeed, by the last half of the 17th century, private lectures on chemistry (figures 2 and 3), complete with demonstrations, were being offered successfully by such chemists as Nicolas Lemery (1645-1715) in Paris, which not only attracted students of medicine and pharmacy, but a substantial number of foreigners and private citizens, including many women (3, 4).

The impact of the teaching of medicine on the teaching of chemistry is perhaps best seen in the case of the Jardin du Roi or Royal Gardens in Paris (5). Beginning with the appointment of the Scottish chemist, William Davisson, in 1648, the positions in chemistry at the Jardin would be held by some of the most illustrious names in 17th and 18th century French chemistry, as shown by the far-from-complete list given in Table 2, and would also engender a famous series of elementary textbooks (6). Just as the teaching of anatomy made use of both a professor, who offered lectures on the subject, and a demon-

Table 1. Some early appointments in medical and pharmaceutical chemistry (3)

A. Libavius	Rothenburg	1592
D. Sennert	Wittenberg	1602
J. Hartmann	Marburg	1609
G. Rolfinck	Jena	1641
G. Davisson	Paris	1648
C. L. van Maets	Leyden	1669

strator or surgeon, who demonstrated the truths of the lecture by dissecting a body in front of the students (figure 4), so the positions in chemistry at the Jardin involved both that of a professor or lecturer and a demonstrator. For just as the truths of internal anatomy were hidden from the eye and had to be revealed to the student by the surgeon's knife, so the truths of chemistry were hidden until extracted and demonstrated by the artifice of the laboratory.

Generally the professor would first deliver his lecture on the facts and theories of chemistry, after which the demonstrator would present experiments to support the professor's assertions. That this arrangement did not always lead to the desired result is illustrated by the case of Louis-Claude Bour-



Figure 2. An early 17th century woodcut of a chemical lecture. Note the lecture assistant tending the furnace in the background.

delain (1696-1777), who was professor at the Jardin in the 1750s, and Guillaume-François Rouelle (1703-1770), who was the demonstrator and is shown in the romanticized 19th century etching in figure 5 beguiling his audience with one of his famous demonstrations. It is reported that Bourdelain would end each lecture with the statement, "Such, gentlemen, are the principles and theory of this operation, as the Demonstrator is about to prove to you by his experiments," whereupon Rouelle would enter and generally proceed to prove the exact

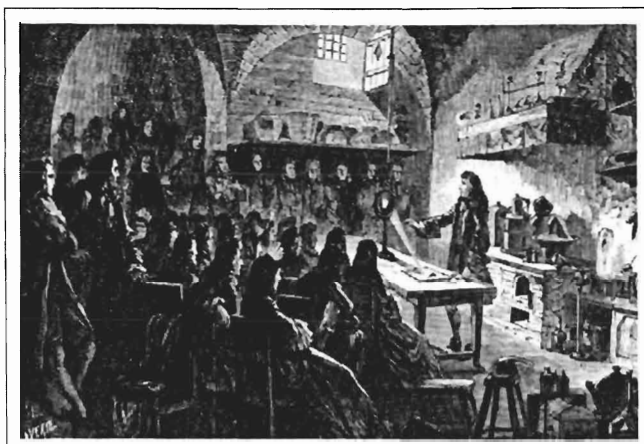

Figure 3. A 19th century reconstruction of one of Lemery's chemical lectures in the late 1600s. Note the large number of women in the audience (39).

opposite. Indeed, Rouelle is rumored to have been highly eccentric. As one observer reported (7):

He [Rouelle] would come to the lecture room elegantly attired with a velvet coat, powdered wig and a little hat under his arm. Collected enough at the beginning of his demonstrations, he gradually became more animated. If his train of thought became obscure, he would lose patience and would gradually divest himself of his clothing, first putting his hat on a retort, then taking off his wig, then untying his cravat. Then, talking all the while, he would unbutton his coat and waistcoat and take them off one after the other. He was helped in his experiments by one of his nephews, but as help was not always to be found close at hand, he would shout at the top of his lungs, "Nephew! O' the eternal nephew" and the eternal nephew not appearing, he would himself depart into the back regions of his laboratory to find the object he needed. Meanwhile he would continue his lecture as though he were still in the presence of his audience. When he returned, he had generally finished the demonstration he had begun and would come in saying, "There, gentlemen, this is what I had to tell you." Then he was begged to begin again, which he always did with the best grace

Table 2. Some early occupants of the positions in chemistry at the Jardin du Roi (5)

G. Davisson	1648
N. LeFèvre	1651
C. Glaser	1660
E. F. Geoffroy	1707
L. Lemery	1730
G. F. Rouelle	1743
L. C. Bourdelain	1743
H. M. Rouelle	1768
P. J. Macquer	1771

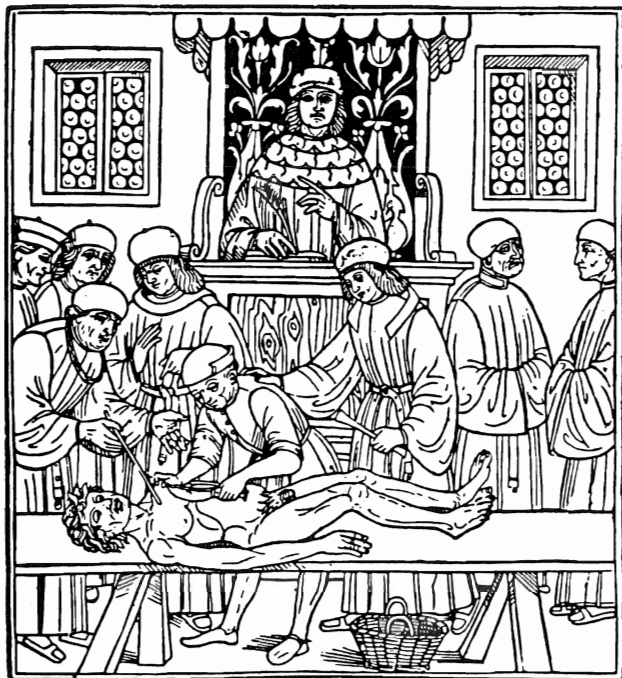

Figure 4. A 16th century medical lecture. The surgeon performs the actual dissection as the professor reads his lecture.

in the world, in the conviction he had merely been badly understood.

By the end of the 18th century the roles of demonstrator and professor had begun to fuse or, at least, to redistribute into professor and lecture assistant. This is certainly implied by the drawing in figure 6 of Antoine-François Fourcroy (1755-1809), who, though professor at the Jardin beginning in 1784, is shown posing with both lecture notes and demonstration apparatus (8). Indeed, in the case of the 18th century Scottish medical schools, the differentiation into professor and demon-

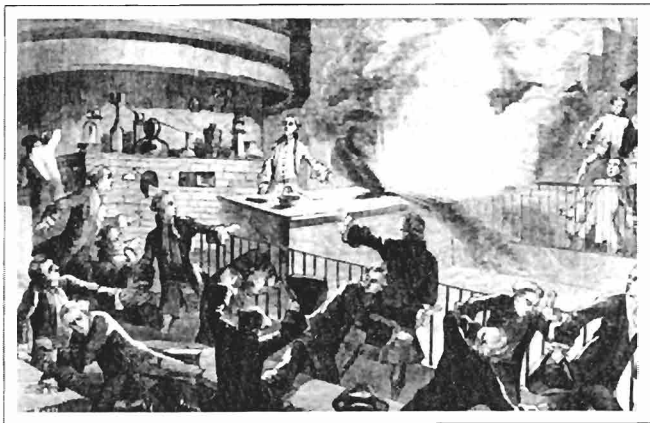

Figure 5. A 19th century reconstruction of one of Rouelle's famous lecture demonstrations at the Jardin du Roi in the 1750s (39).

strator seems never to have occurred, and, as far as we know, Joseph Black (1728-1799) did his own demonstrations (figure 7) with the help of an assistant (9). Certainly this was true in France as well by the first decades of the 19th century, as shown in the drawing of Louis-Jacques Thenard (1777-1857) in figure 8 lecturing on chemistry to a class of medical students in the early 1800s (10).

Chemistry was taught solely by demonstration for the first 225 years of its academic existence, that is, from the beginning of the 17th century until the second or third decade of the 19th,

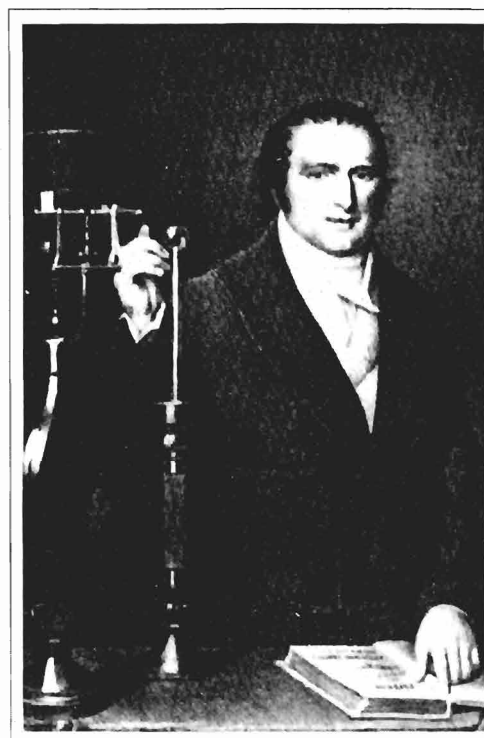

Figure 6. Antoine-François Fourcroy (1755-1809) posing with his lecture equipment and notes (8).

during which time it largely retained its status as an introductory service course for students in medicine and pharmacy. Consequently, it is really not possible to separate out an explicit demonstration literature for this period, since the use of demonstrations was the implicit basis of all aspects of chemical pedagogy, from the organization of textbooks to the design of teaching facilities.

Its impact on the latter can be seen in John Webster's (1793-1850) design for the chemical laboratory at Harvard University, which he inserted as a plate (figure 9) in the 1826 edition of his textbook, *A Manual of Chemistry* (11). As can be seen, it is really a plan of what we would call a lecture hall and prep room. Indeed, the use of the word laboratory during this period almost invariably refers to a work room off the front of a lecture hall in which the professor, and perhaps one or two lecture



Figure 7. John Kay's caricature of Joseph Black at his lecture bench. The white squares cluttering the bench top are Black's lecture notes.

assistants, could prepare lecture demonstrations and occasionally conduct original research. Private research laboratories and large teaching laboratories for students were generally nonexistent. Other examples of similar design include the famous laboratory at the Royal Institution used by both Humphry

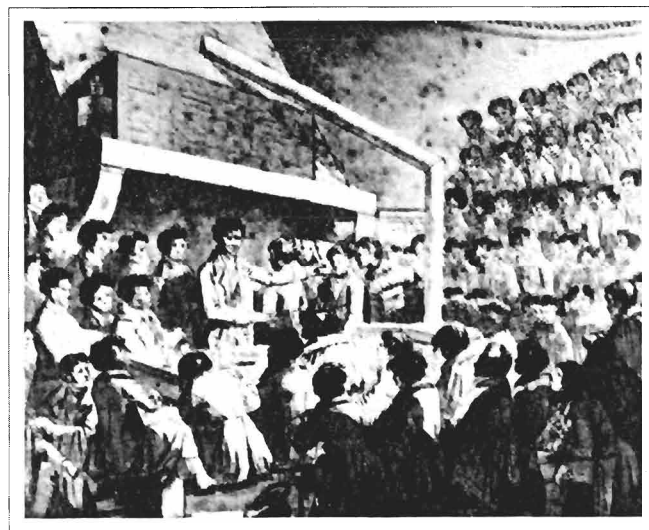

Figure 8. Louis-Jacques Thenard lecturing on chemistry to a class of medical students in the early 1800s (10).

Davy (1778-1829) and Michael Faraday (1791-1867) (12) and Robert Hare's (1781-1858) laboratory at the University of Pennsylvania (figure 10), in which virtually all of the laboratory operations, including the apparatus and chemical storage areas, were open to the view of the audience (13).

Webster, by the way, is known in Harvard chemical lore for his famous volcano demonstration - a large plaster mountain filled with potassium perchlorate and sugar which Webster

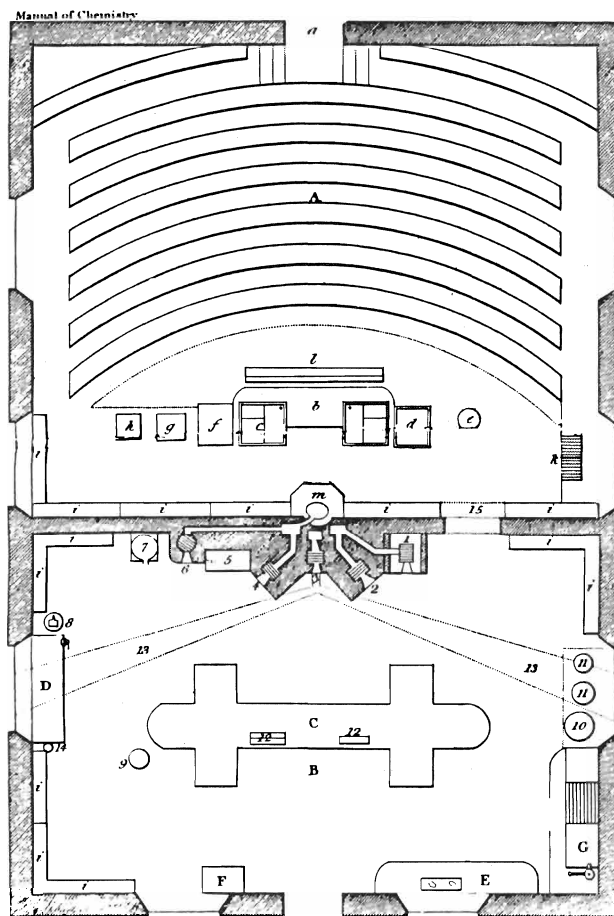

Figure 9. John Webster's floor plan for his lecture hall and laboratory at Harvard, circa 1826 (11).

would ignite without warning using a drop of sulfuric acid and then dash for the nearest door, leaving the students to fend for themselves (14). Webster was also eventually hung for murder - not for igniting one of his students on fire with his volcano, but for murdering a fellow faculty member in the medical school (15).

Since the textbooks of the period were often only thinly disguised transcriptions of the actual lectures, they usually incorporated direct verbal descriptions of the demonstrations as they were performed in the course of the lecture itself. In a survey of 68 American texts published between 1788 and

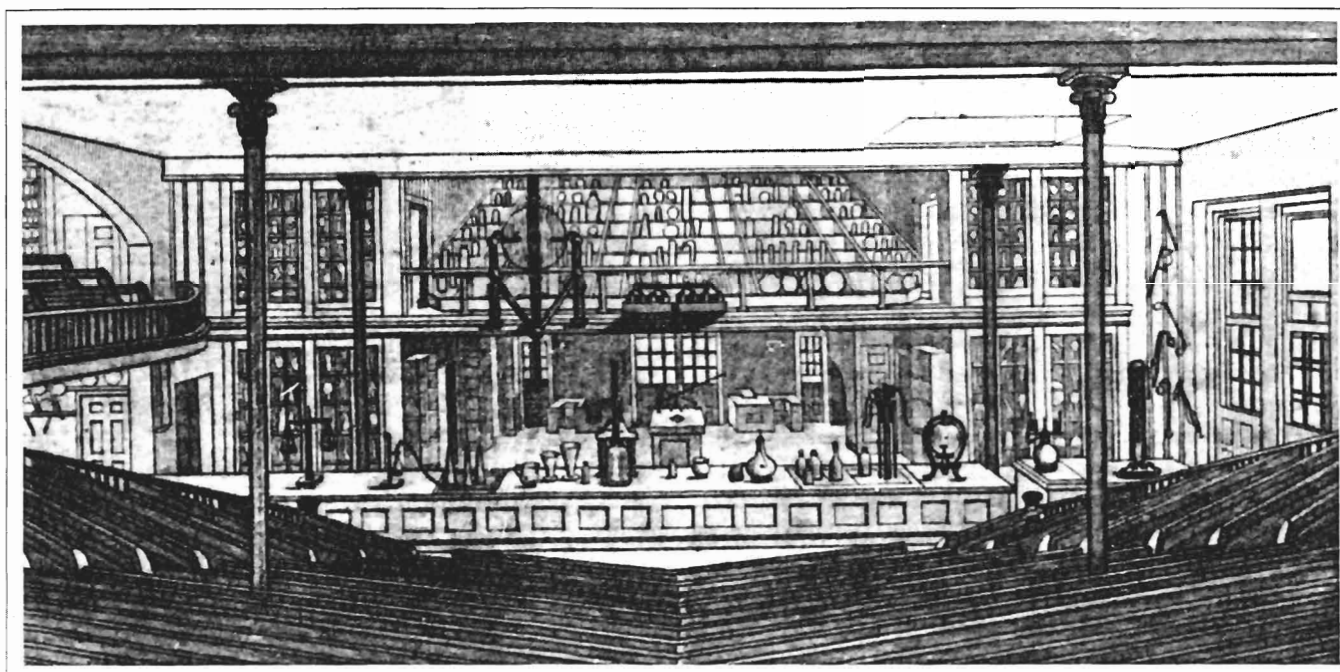

Figure 10. Robert Hare's laboratory and lecture hall at the University of Pennsylvania Medical School, circa 1830 (13).

1890, Mangery (16) found that an average of 30 demonstrations and 68 experiments were described, the record being held by James Cutbush's (1788-1823) 1813 text, which contained 820 (17). Often these were simply part of the ongoing flow of the text. In other cases the authors used various devices to draw attention to them. Thus Thomas Duché Mitchell's (1791-1863) text, *Elements of Chemical Philosophy*, published in 1832, used the marginal notation of "Experiment" to indicate at what points in the lecture Mitchell performed actual classroom demonstrations (18), whereas Robert Hare, in his *Compendium of Chemistry*, which went through numerous editions between 1822 and 1840, divided his text into sections in which each descriptive segment was followed by a section entitled "Experimental Demonstrations", much as Rouelle had followed Bourdelain a century earlier (19).

Hare's compendium was in many ways a pictorial guidebook to the lecture demonstrations used in his introductory service course for the medical students at the University of Pennsylvania, and his career seems to have been largely devoted to their improvement and elaboration. The result of this obsession was an odd mixture of success and failure. Success, in that the improvements led to many novel discoveries and several new forms of apparatus - including the oxyhydrogen blowpipe - and resulted in one of the most productive research records of any American chemist prior to the Civil War. Failure, in that the resulting demonstrations became so elaborate that they virtually ceased to have pedagogical value. This is illustrated by Hare's apparatus for demonstrating the reaction of oxygen and hydrogen to form water (figure 11) - an

elaborate complex of tubes and valves which can hardly be considered an improvement over the simple expedient of lighting the end of a zinc-acid hydrogen generator inside a large dry bell jar, as in the standard demonstration. Indeed, Hare seems to have been aware of this failing, as he confessed in his introduction that one reason for writing the compendium was the fact that his apparatus had become so complex that students were unable to follow the demonstrations without having a printed illustration and description to study before class. In fairness, I should point out that not all of Hare's demonstrations were this elaborate, and occasionally one stumbles across an old favorite, like the oxygen-hydrogen cannon shown in figure 12.

An even more extreme version of Hare's approach is found in Amos Eaton's (1776-1842) 1833 text, *The Chemical Instructor*, in which each topic was divided into a "Proposition" or statement of fact, followed by "Illustrations" or supporting lecture demonstrations, followed by the theoretical "Rationale" and by practical "Applications" (20). Eaton's text also calls to mind the existence of another nonacademic tradition of lecture demonstrations - that of the itinerant lecturer. These private lecturers, who were quite popular in the late 18th and early 19th centuries in Great Britain and America, earned their livelihood or supplemented it, in the case of some university professors, by traveling from town to town to give short courses on chemistry, amply illustrated with demonstrations, to groups of private citizens, usually under the sponsorship of local ministers, educators or natural history societies. Indeed, Miles has assembled a list of some 50 such chemical

lecturers who were active in the United States in the 19th century (21).

Eaton's text is actually a handbook for the itinerant chemical lecturer, outlining the minimum content for a proper course of lectures, what demonstrations to use, what apparatus to buy, etc. It also offered more general advice, warning the would-be lecturer to avoid "those blazing, puppet show-like experiments common with quacks and impostures" and local authorities to avoid (20):

... those peddling swindlers who offer to sell tickets for insulated [i.e., single] lectures, [instead of a full course of 15-30] who ought to be despised. They are always contemptible quacks of no integrity and they ought not be allowed to sleep near traveler's baggage at public inns.

Finally, Eaton argued that (20):

... every city, large village, or populous district ought to be too liberal to depend on itinerating lecturers. They should support permanent teachers of the right kind; particularly avoiding those self-styled chemists who swarm about our large towns, possessing no qualifications but impudence. These are chiefly illiterate Scotch, Irish or English. But justice demands that we make many honorable exceptions.

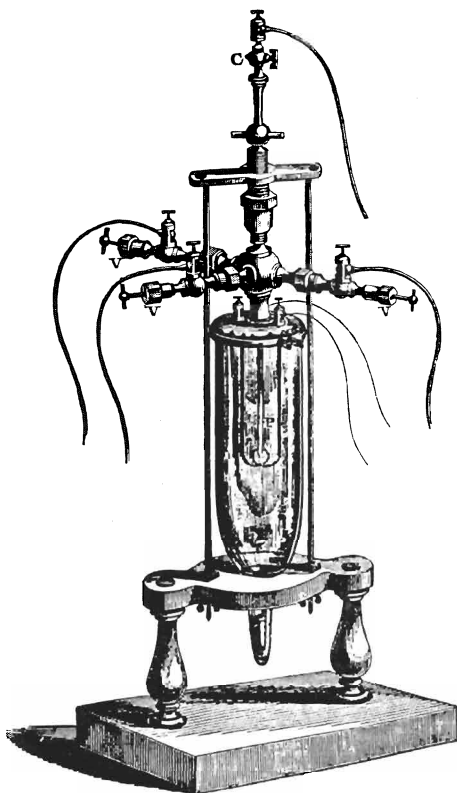

Figure 11. Hare's elaborate apparatus for demonstrating the synthesis of water (19).

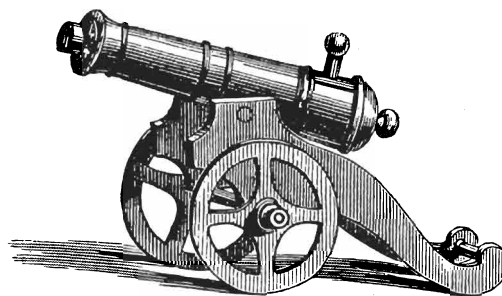

Figure 12. Hare's brass oxygen-hydrogen cannon, which was ignited with a spark from a Leyden jar (19).

I presume that Eaton would have included Dr. Alyea - whose later career must resemble in many ways the hectic life style of the itinerant lecturer - in his list of honorable exceptions!

Just as laboratory design and textbook organization were both inexorably intertwined with chemical demonstrations during this period, so too was the literature dealing with chemical manipulation and the chemistry set. The former was intended to introduce novices to the more common kinds of apparatus and to train them in the simple operations of the laboratory, whereas the latter was intended to provide educational amusement. In the case of the manipulation literature, the experiments used often doubled as standard lecture demonstrations for the simple reason that proficiency in the art of lecture demonstration was considered as part of the education of a well-trained chemist. As for the chemistry set literature, obviously whatever could entertain and instruct at home could do the same in the classroom. Michael Faraday's classic *Chemical Manipulation* (1827) and George W. Francis' encyclopedic *Chemical Experiments Illustrating the Theory, Practice and Application of the Science of Chemistry* (1854)

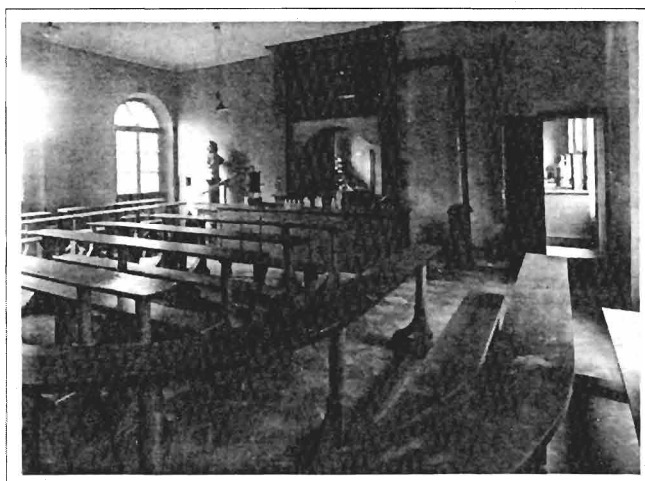

Figure 13. Liebig's lecture hall at Giessen. Note the door leading to the laboratory and the opening behind the lecture bench (38).



Figure 14. The student laboratory-prep room behind Liebig's lecture hall at Giessen. Note the opening for passing demonstrations through to the lecture table (38).

come immediately to mind as typical early 19th century examples of the first of these traditions, and Fredrick Accum's *Chemical Amusement* (1817) is perhaps the most famous example of the second. In fact, the literature in both of these areas is surprisingly rich, and I have discussed both traditions in greater detail elsewhere (22, 23).

As already noted, the transition from the demonstration method to the laboratory method of teaching chemistry began in the 1820s and 1830s and was coextensive with the rise of complete chemical curricula in the university designed to train professional chemists, in contrast to the earlier introductory service course for other professions. As everyone knows, the small teaching laboratory started by Justus Liebig (1803-1873) at Giessen in 1824 played a key role in this process and, indeed, the teaching facilities at Giessen reflect this transition in an interesting way (24, 25). The central feature, as in Webster's plan, still appears to be a lecture hall (figure 12) directly connected at the front to a laboratory (figure 13) for the preparation of demonstrations. However, this preparation room is now large enough to allow 20 or more students to also work directly on their own experiments. In other words, it can double as a traditional prep room and as a teaching laboratory.

Incidentally, Liebig himself doesn't appear to have been much of a success as a lecture demonstrator, at least if we are to believe Carl Vogt's description of his experiences in Liebig's lectures in 1834 (26):

He [Liebig] was then at the height of his power and enthusiasm and his every word proclaimed his determination to give us the most thoroughgoing instruction. The lectures were, certainly, not models whether one considered the descriptions, the performance of the experiments, or the derivations of the conclusions and inferences. Liebig was at that time still overly hasty in everything that he

undertook. He was very prone to leave out the intermediate steps of a course of reasoning. Starting out from a major premise, he instantly came down with both feet plump upon the final conclusion. In the lecture experiments he constantly seized the wrong materials or succeeded only because the assistants on the right hand and the left placed the proper instruments and reagents into his hands. The excellence of his manipulation in the laboratory was equaled only by his lack of success in the lecture-demonstration; and in spite of these defects, we were carried along and inspired by his ardor for his subject. "Now, gentlemen!" he would say, "I have a liquid in this test tube. It is a solution of acetate of lead. You might believe it to be water - it appears just like water - but I would be able to show you that it is a solution - for the present you will have to take my word for it. Well then, this water is a solution of lead acetate! And here in this glass you see a yellow liquid! (Takes the glass and looks at it.) That's right! A yellow liquid! This yellow liquid is a solution of potassium chromate in water. (He puts down both glasses, goes to the board, takes the chalk and writes some formulas.) ... Now gentlemen, I pour the two liquids together. (He pours them together, goes to the board and completes his equations.) You see, a chemical decomposition takes place. The acetic acid combines with the potassium and forms acetate of potassium which is soluble in water and colorless; the chromic acid combines with the oxide of lead and forms lead chromate which is insoluble in water and produces a beautiful yellow precipitate which is used as a dye, as chrome yellow!" He shakes the glass and goes,

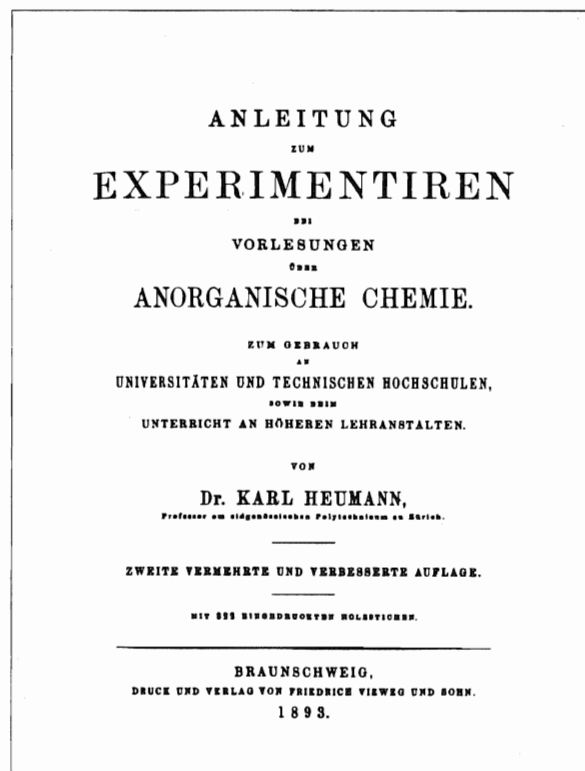

Figure 15. The title page of the second edition (1893) of Heumann's book on lecture demonstrations.

constantly shaking it, up and down, along the front row of the students, all the time repeating, "Chrome yellow! A beautiful yellow precipitate! You see gentlemen, you see!" At last he raises the glass and holds it in front of his own eyes. "That is you see nothing - the experiment has failed." (In a rage he throws the glass in a corner.) Ettl, the assistant, shrugs his shoulders without speaking and points to a glass still on the table as a way of telling the students that the professor in his zeal has again used the wrong solution.

A reproduction of Liebig's original lecture notes, complete with detailed descriptions of his lecture demonstrations, has recently been published by Krätz and Priesner (27).

By the 1870s the laboratory and research aspects of chemical instruction had become sufficiently developed and differentiated from the older demonstration aspects that we can begin to talk of an explicit and separate demonstration literature. The first book to appear within this tradition was the 1876 text, *Anleitung zum Experimentieren bei Vorlesungen über anorganische*

Chemie, by Karl Heumann (1850-1893) of the Technische Hochschule in Darmstadt (28). In this book he outlined the design of a proper lecture hall and demo prep room and explicitly described hundreds of demonstrations based on those used by Bunsen, Liebig, Hofmann, and others. By 1893, when Heumann had moved to the ETH in Zürich, the book, then in its second edition, was more than 700 pages thick and contained over 322 illustrations. The copy in the Oesper Collection at the University of Cincinnati (figure 15), which dates from the early days of its chemistry department, has been rebound as two separate volumes - one for demonstrations relating to the nonmetals and one for demonstrations relating to the metals - and has interleaved blank pages containing the comments of past faculty, in both German and English, on improvements and alterations in the demonstrations.

Among the famous chemists that Heumann mentioned, the name of August Wilhelm Hofmann (1818-1892) should be

singled out for special attention. In 1865 he published a series of 12 introductory lectures on chemical theory which stressed the central importance of Avogadro's hypothesis and the newly developed valence concept. Though not intended as a handbook of lecture demonstrations, the book gave detailed accounts, complete with illustrations, of the demonstrations used by Hofmann in his lectures, many of which employed apparatus specially designed by him. These demonstrations were quickly adopted by others and laboratory supply catalogs for the last quarter of the 19th century carried an extensive line of "Hofmann Lecture Apparatus", including the well-known Hofmann electrolysis cell. It is doubtful whether any other single chemist has ever originated so many pieces of commercially

manufactured lecture apparatus (29).

Even more impressive than Heumann's epic tome was Rudolf Arendt's (1828-1902) 1881 text, *Technik der anorganischen Experimentalchemie*, which by 1910 had reached a fourth edition with over 1,011 pages

and 1,075 illustrations (30). Arendt, by the way, should be of great interest to chemical educators since he was, as far as I know, the first specialist in this field, teaching courses in the pedagogy of chemistry to would-be science teachers at Leipzig and writing textbooks on how to scientifically teach chemistry (31).

The first American book on chemical demonstrations was published in 1877 by Samuel P. Sadtler (1847-1923) and carried the somewhat lengthy title of *Chemical Experimentation, Being a Handbook of Lecture Experiments in Inorganic Chemistry* (32). In his introduction, Sadtler, who was at the time an Assistant Professor of Chemistry at the University of Pennsylvania, claimed that, prior to the publication of his book, there had been "in the English language no book designed to give full instructions for the illustration of chemical lectures". Though the vast majority of his illustrations were taken from Heumann, Sadtler further claimed that most of his

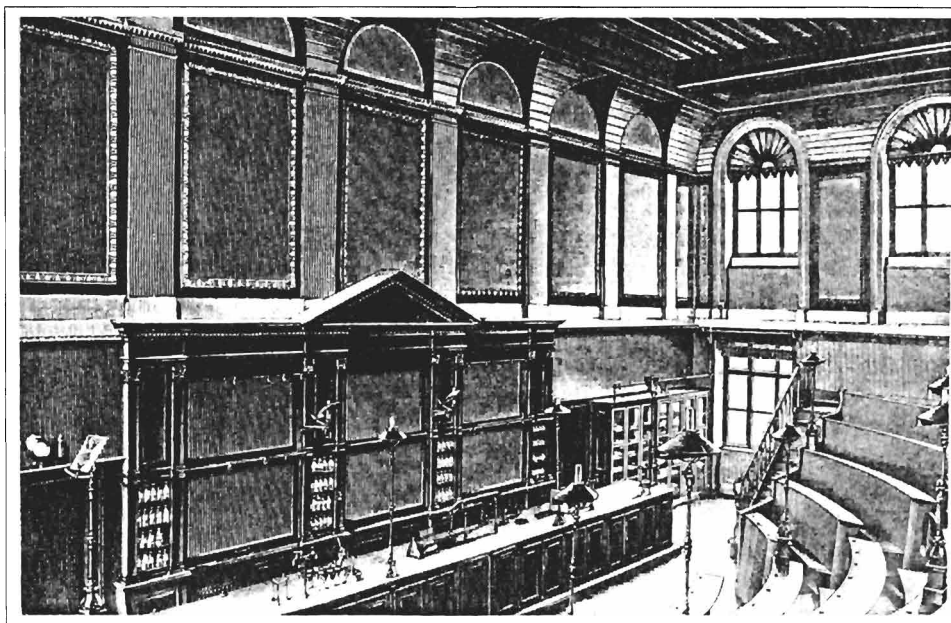

Figure 16. Heumann's lecture hall at the ETH in Zürich, circa 1893 (28).

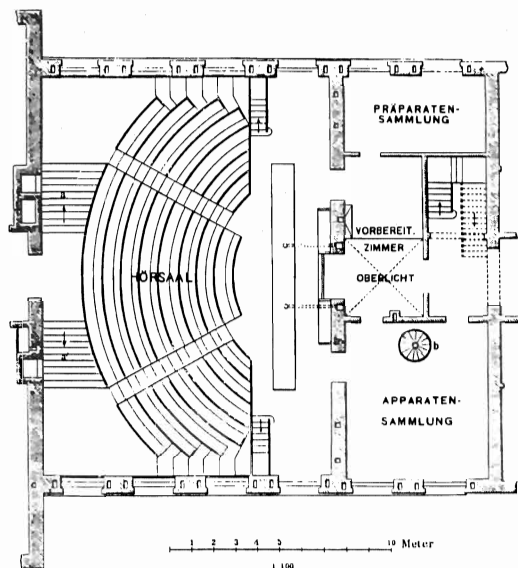

Figure 17. The floor plan of Heumann's lecture hall and prep room at the ETH in Zürich (28).

book had been written without knowledge of Heumann's work, which had been brought to his attention only after he had written Heumann's publisher for permission to use illustrations from other volumes published by them. In addition to some last minute copying from Heumann, Sadtler also mentioned having made use of Hofmann's famous text, a volume by Gorup-Besanez and an earlier inorganic text by Arendt, which I haven't seen. Sadtler's book was only 225 pages long and did not cover questions of lecture and demo room design. It also appears not to have been very successful and was rapidly displaced by the more elaborate books by Heumann and Arendt.

Assuming that Sadtler's complaint about the lack of English-language books on chemical demonstrations was true, then the first British book to deal explicitly with this subject would appear to be the 1892 volume, *Chemical Lecture Experiments*, by G. S. Newth, the chemical demonstrator at the Royal College of Science in South Kensington (33).

Much less complete than its German predecessors, it had, like Sadtler, nothing to say about lecture and demo room design and dealt only with demonstrations relating to the nonmetals.

A second American volume dealing with chemical demonstrations, and having the same title as Newth's book, was published by Francis Gano Benedict (1870-1957) of Wesleyan University in 1901 (34). As with the other English-language books, it also lacked sections on lecture and demo room design and was largely based, by the author's own admission, on the earlier works by Heumann, Arendt and Newth.

The most intriguing and, by modern standards, the most depressing parts of the texts by Heumann and Arendt are their descriptions of the lecture halls and demo rooms. Heumann

Figure 19. A close-up of the bench-top hood system recommended by Arendt (30). See also figure 18.

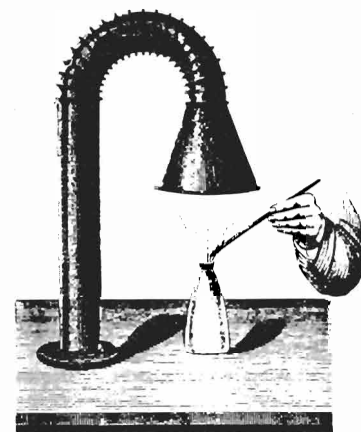

included a plate of his lecture hall at Zürich (figure 16) as well as a floor plan (figure 17) and Arendt specified the most minute details of the construction of a proper lecture bench (figure 18), including a table-top hood system for obnoxious odors and smoke (figure 19), a built-in safety screen and pneumatic trough, which could be cranked in and out of the desk top (figure 20), and such supplementary devices as mirrors to enhance the visibility of certain demonstrations (figure 21).

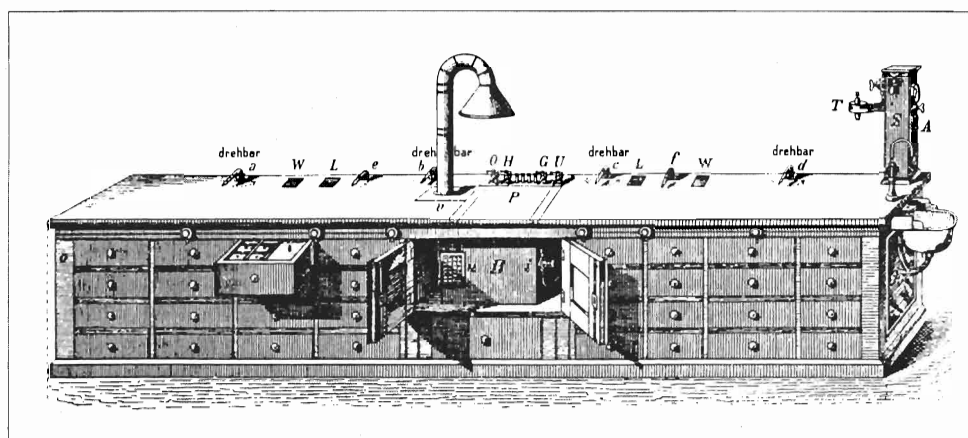

Figure 18. Arendt's design for a lecture bench (30).

The use of optically projected chemical demonstrations (figures 22-24), including an early forerunner of the modern overhead projector, was also discussed by Arendt and in greater detail

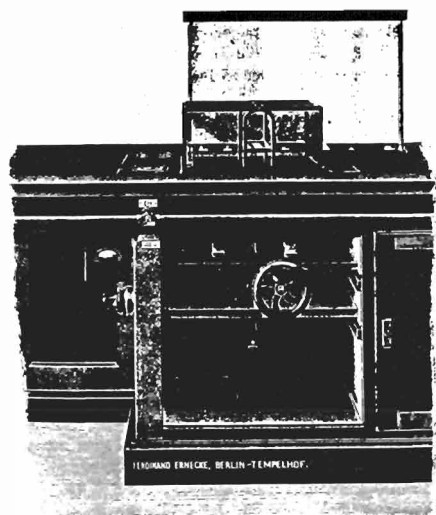

Figure 20. A pneumatic trough and glass safety shield which crank into the top of the lecture bench (30).

in an 1890 volume on optical projection by Lewis Wright (35).

Laboratory designers in Europe, Britain and the United States took these suggestions seriously, at least until the 1930s, as witnessed by lecture halls built in Germany in the 1850s (figure 25); at Yale in 1887 (figure 26); at Lehigh in 1884 (figure 27); at MIT in 1883 (figure 28); at the Imperial College of Science in London in 1906 (figure 29); at Leipzig in 1897 (figure 30), where Wilhelm Ostwald (1853-1932) is shown giving an inaugural lecture in his new lecture hall to an audience containing most of the great names of 19th century physical chemistry; and, finally, at Cincinnati in 1895 (figure 31). This last lecture hall, by the way, had, according to contemporary accounts, the crank-up safety shields recommended by Arendt.

Though this concern for quality lecture demonstration facilities - the idea that these must be as specifically designed as the teaching and research laboratories - continued into the next generation of buildings constructed in the 1920s and



Figure 21. Bench-top mirrors to enhance the visibility of certain demonstrations (30).

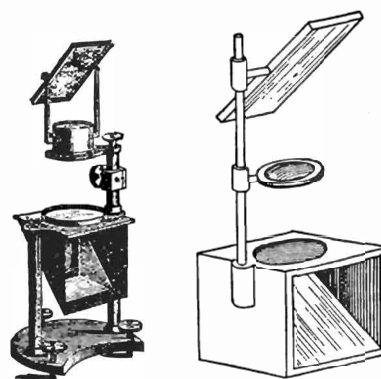

Above: Figure 22. Early examples (circa 1890) of overhead projectors. Both of these made use of the light from a conventional horizontal projector which was directed at the mirror mounted in the base (35).

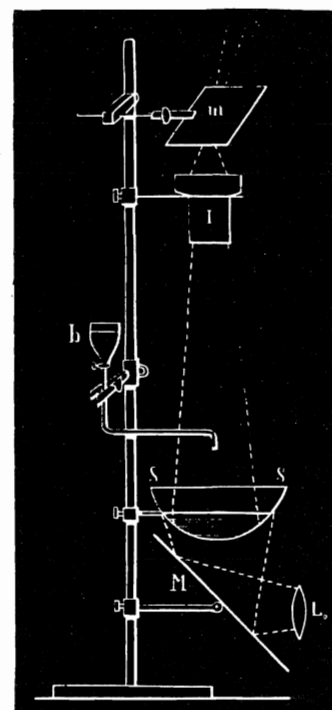

Right: Figure 23. Another setup for the overhead projection of a chemical reaction as described by Wright in 1890 (35).

Below: Figure 24. A cell for the horizontal projection of chemical reactions made by compressing a curved section of rubber tubing between two glass plates. The plates, in turn, are pressed together by a set of outer metal plates held together by thumb screws. After the demonstration is over, the plates are unscrewed and the cell is disassembled for easy cleaning (35).

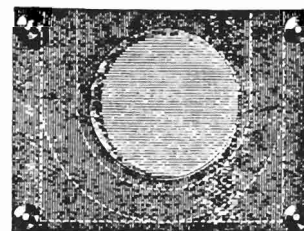

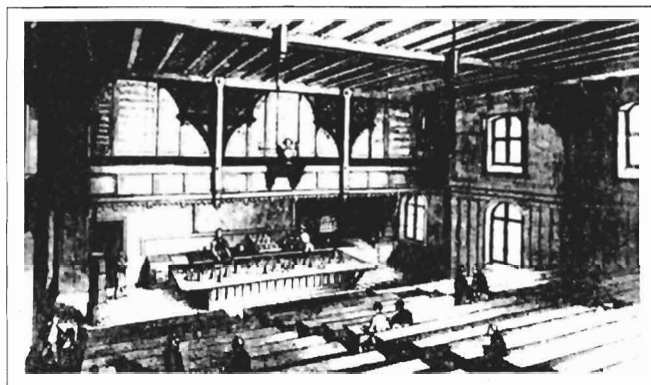

Figure 25. German chemical lecture hall, circa 1850 (38).

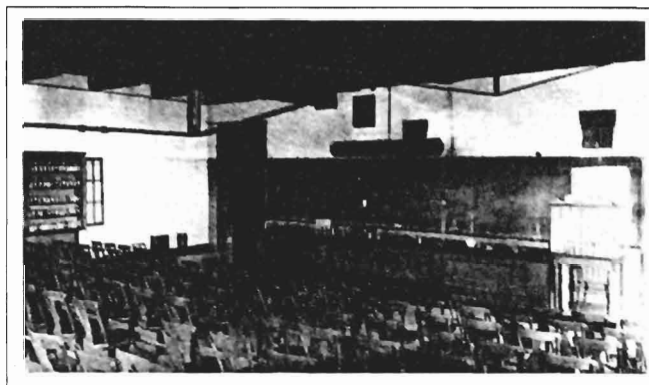

Figure 28. The chemical lecture hall at MIT in 1883 (36).

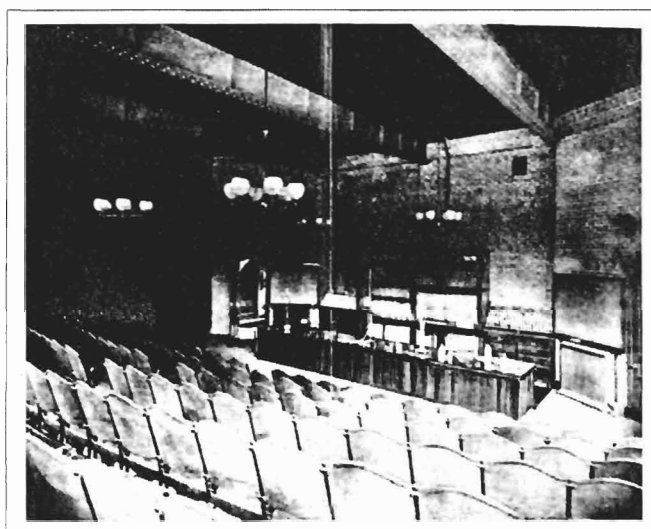

Figure 26. The chemical lecture hall at Yale University, 1887 (36).

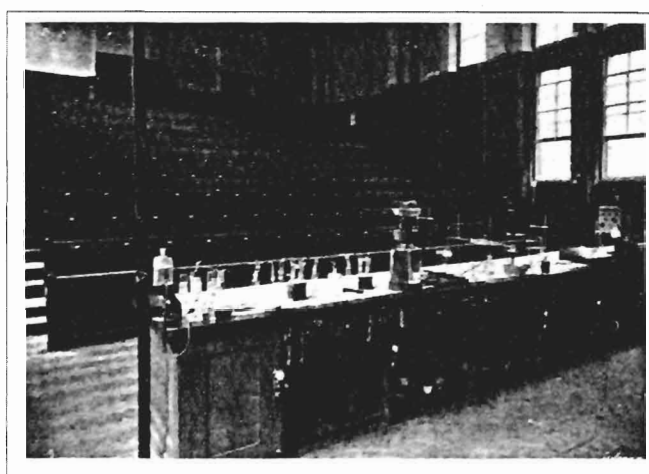

Figure 29. The chemical lecture hall at Imperial College London, circa 1906 (37).

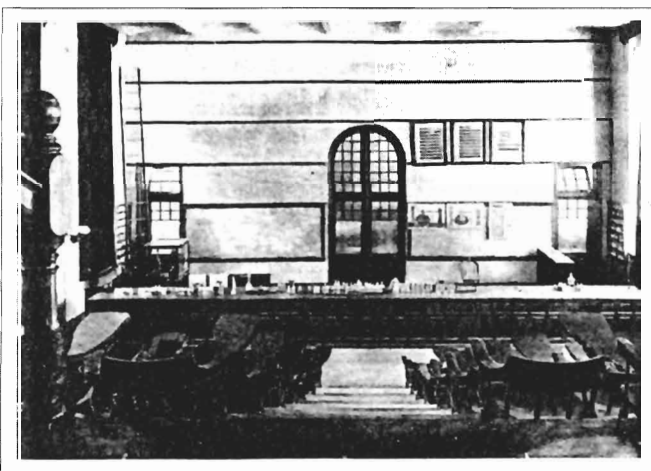

Figure 27. The chemical lecture hall at Lehigh University, 1884 (36).

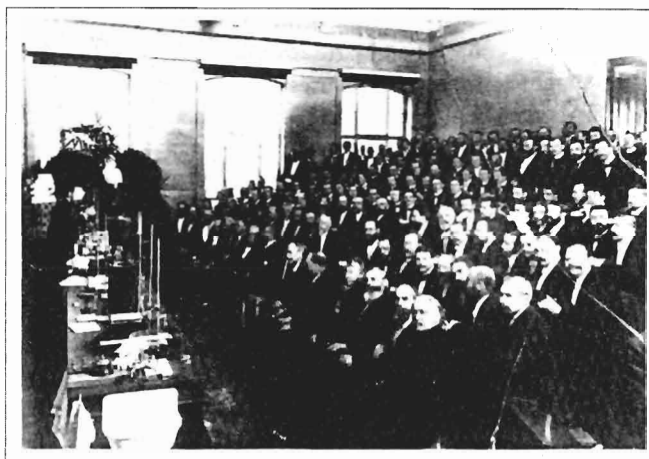

Figure 30. Wilhelm Ostwald giving the inaugural lecture for his new institute at Leipzig in 1897. Among the members of the audience are Arrhenius, van't Hoff, Nernst and Boltzmann (38).

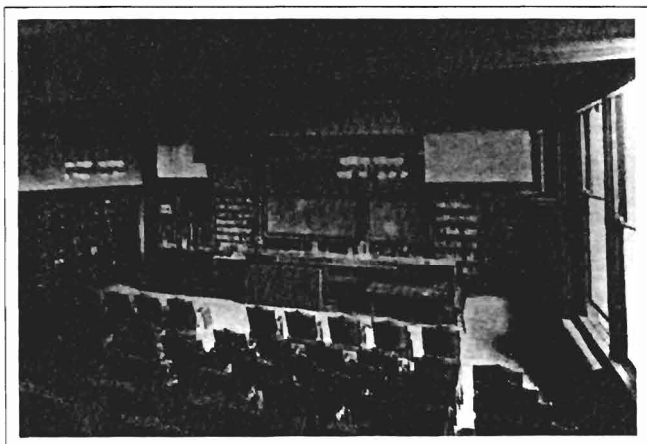

Figure 31. The chemical lecture hall at the University of Cincinnati, 1895 (38).

1930s, the same, alas, cannot be said for many chemistry buildings built in the 1960s and 1970s. I can't count the number of schools I have visited in which I am told that there is no large lecture hall and demo room in the chemistry building and that most introductory lectures are not even taught there, but in lecture halls on other parts of the campus - thus necessitating the dangerous transport of chemicals and apparatus. Often I'm taken over to see "old chemistry", refitted and occupied by sociology or psychology, and wistfully shown the old lecture hall and demo room - now no longer suited for their original purpose.

I'm unsure just what accounts for this sad break in the continuity of a great teaching tradition. Perhaps in their stampede to evolve into research schools and to partake of the government-subsidized upgrades in equipment and research facilities which accompanied the spate of new buildings constructed in the 1960s and 1970s, many departments wished to deemphasize their traditional teaching roles. Perhaps the increasingly common reluctance of administrators to invest in lecture halls and classrooms, which yield no grant overhead, instead of in research laboratories and centers, is responsible - or the increasingly common fantasy of campus scheduling that all classrooms are interchangeable and can be assigned solely on the basis of student numbers and maximized time usage. Whatever the reasons, there is little doubt that a tradition of chemical pedagogy - one indeed that is now almost 400 years old - has undergone a sad decline and that many members of the Division of Chemical Education, including Dr. Alyea, have had to devote a substantial portion of their careers to reminding their fellow chemists of a set of values and techniques which, 50 years ago, were taken as given in virtually every chemistry department.

References and Notes

1. For an earlier treatment of this topic see H. Toftlund, "History of the Lecture Demonstration", *Educ. Chem.*, **1988**, *25*, 109-111.
2. A. Debus, "Quantification and Medical Motivation: Factors in the Interpretation of Early Modern Chemistry", *Bull. Hist. Chem.*, **1988**, *1*, 4-5.
3. R. Multhauf, *The Origins of Chemistry*, Oldbourne, London, 1966, Chap. 9.
4. O. Hannaway, *Early University Courses in Chemistry*, Ph.D. Thesis, University of Glasgow, Glasgow, 1965.
5. J.P. Contant, *L'enseignement de la chimie au jardin royal des plantes de Paris*, Cahors, Paris, 1952.
6. J. Reid, *Humour and Humanism in Chemistry*, Bell, London, 1947, Chap. 6.
7. Quoted in E. J. Holmyard, *Makers of Chemistry*, Oxford University Press, Oxford, 1931, pp. 189-191. See also P. LeMay and R. E. Oesper, "The Lectures of Guillaume François Rouelle", *J. Chem. Educ.*, **1954**, *31*, 338-343.
8. W. A. Smeaton, *Fourcroy, Chemist and Revolutionary, 1755-1809*, Heffer, Cambridge, 1962.
9. For descriptions of Black's lecture technique, see reference 6, Chap. 8.
10. P. Thenard, *Un grand Français, Le Chimiste Thenard, 1777-1857*, Dijon, 1950.
11. J. Webster, *A Manual of Chemistry*, Richards and Lord, Boston, MA, 1826.
12. D. Chilton and N. G. Coley, "The Laboratories of the Royal Institution in the Nineteenth Century", *Ambix*, **1980**, *27*, 173-203.
13. E. F. Smith, *The Life of Robert Hare*, Lippincott, Philadelphia, PA, 1917.
14. I. B. Cohen, *Some Early Tools of American Science: An Account of the Early Scientific Instruments and Mineralogical and Biological Collections at Harvard University*, Harvard, Cambridge, MA, 1950, pp. 18-20, 93-95.
15. For a recent account of the murder, see S. Schama, "Death of a Harvard Man", *Granta*, **1990**, *34*, 13-76.
16. P. W. Mangery, *An Analysis of Chemistry Texts Used in the American Secondary Schools Before 1890*, Ph.D. Thesis, University of Pittsburgh, Pittsburgh, PA, 1959.
17. J. Cutbush, *The Philosophy of Experimental Chemistry*, Vols. 1 and 2, Pierce, Philadelphia, PA, 1813.
18. T. D. Mitchell, *Elements of Chemical Philosophy*, Corey and Fairbank, Cincinnati, OH, 1836.
19. R. Hare, *A Compendium of the Course of Chemical Instruction in the Medical Department of the University of Pennsylvania*, 3rd ed., Auner, Philadelphia, PA, 1833.
20. A. Eaton, *Chemical Instructor, Containing Instructions for Learning and Teaching Chemistry*, 4th ed., Parker, Troy, NY, 1833.
21. For a study of 19th century itinerant lecturers in chemistry, see W. Miles, "Public Lectures on Chemistry in the United States", *Ambix*, **1968**, *15*, 129-153.
22. W. B. Jensen, "Michael Faraday and the Art and Science

of Chemical Manipulation", *Bull. Hist. Chem.*, **1991**, *11*, in press.

23. W. B. Jensen, *Two Centuries of the Chemistry Set*, to be published.

24. For a study of the organization of Liebig's laboratory, see M. W. Rossiter, *The Emergence of Agricultural Science: Justus Liebig and the Americans, 1840-1880*, Yale, New Haven, CT, 1975, Part II, and, more recently, F. L. Holmes, "The Complementarity of Teaching and Research in Liebig's Laboratory", *Osiris*, **1989**, *5*, 121-164.

25. For a current description of the Liebig laboratory and museum, see S. Heilenz, *Das Liebig-Museum in Giessen*, Feuer'schen Universitäts-Buchhandlung, Giessen, 1986.

26. Quoted in H. B. Good, "On the Early History of Liebig's Laboratory", *J. Chem. Educ.*, **1936**, *13*, 557-562. I have edited parts of the translation for greater clarity.

27. O. P. Krätz and C. Priesner, eds., *Liebigs Experimentalvorlesung*, Verlag Chemie, Weinheim, 1983.

28. K. Heumann, *Anleitung zum Experimentieren bei Vorlesungen über anorganische Chemie*, 2nd ed., Vieweg, Braunschweig, 1893.

29. For background on Hofmann and his book, see W. B. Jensen, "Reinventing the Hofmann Sodium Spoon", *Bull. Hist. Chem.*, **1990**, *7*, 38-39.

30. R. Arendt, *Technik der anorganischen Experimentalchemie*, 4th ed., Voss, Leipzig, 1910.

31. For biographical details on Arendt, see F. Etzold, "Rudolf Arendt", *Berichte*, **1902**, *35*, 4542-4549 and N. Just, "Rudolf Arendt (1828-1902): Chemiker und Lehrer - sein methodisches Unterrichtswerk im Spiegel der Zeitgenossen", *Mitteil. Fachgr. Gesch. Chem. GDCh.*, **1988**, *1*, 70-78.

32. S. P. Sadtler, *Chemical Experimentation, Being a Handbook of Lecture Experiments in Inorganic Chemistry*, Morton, Louisville, KY, 1877.

33. G. S. Newth, *Chemical Lecture Experiments*, 2nd ed., Longmans, Green, London, 1896. An earlier example may be E. Frankland, *How to Teach Chemistry. Hints to Science Teachers and Students*, London, 1872.

34. F. G. Benedict, *Chemical Lecture Experiments*, Macmillan, New York, NY, 1901.

35. L. Wright, *Optical Projection: A Treatise on the Use of the Lantern in Exhibition and Scientific Demonstration*, Longmans, Green, London, 1890, Chap. 16.

36. W. H. Chandler, *The Construction of Chemical Laboratories*, Government Printing Office, Washington, D.C., 1893.

37. W. A. Tilden, *Chemical Discovery and Invention in the Twentieth Century*, Routledge, London, 1916.

38. The Oesper Collection of Prints and Portraits in the History of Chemistry, University of Cincinnati.

39. L. Figuier, *Vies des savants*, Vols. 4 and 5, Hachette, Paris, 1870.

William B. Jensen is Oesper Professor of the History of Chemistry at the University of Cincinnati, Cincinnati, OH 45221.

HENRY MARSHALL LEICESTER (1906-1991)

A Memorial Tribute

George B. Kauffman, California State University - Fresno

Henry Marshall Leicester, Professor Emeritus of Biochemistry at the Dental School of the University of the Pacific and an internationally renowned authority on the history of chemistry and the biochemistry of teeth, died peacefully in his sleep at his home in Menlo Park, California on 29 April 1991 at the age of 84. He had suffered from Parkinson's disease for almost two decades, but he remained active and alert until the end.

Born in San Francisco, California on 22 December 1906 (the year of the earthquake and fire), Henry was the youngest of the three children of self-taught tax attorney John Ferard Leicester, formerly from England, and Elsie Hamilton Allen Leicester, a secretary and later an heiress, formerly from Virginia. His talent for self-expression probably derived from his father's influence, while his patience and quiet courtesy were due to his mother's influence. His interest in hiking, especially in the Sierras, stemmed from his parents, who were both among the earliest members of John Muir's Sierra Club.

A precocious youth, he graduated early from San Francisco's Lowell High School and at the age of 16 entered Stanford University, from which he received his A.B. (1927), M.A. (1928), and Ph.D. degrees (1930, in organic chemistry), the last at the age of 24. Because of the scarcity of permanent positions during the Depression he spent the next eight years in a variety of activities - travel in Europe (including research in Zürich and London), a year as Instructor at Oberlin College, part of a year at the Carnegie Institution in Washington, and one and three years as Research Associate at Stanford and the Midgley Foundation at Ohio State University, respectively.

During this period he published six articles on selenium compounds (two with F. W. Bergstrom, based on his dissertation research) (1, 2, 5, 7, 9, 10), one on carotene (with Harry N. Holmes) (3), one on betulin derivatives (with 1939 Nobel chemistry laureate Leopold Ruzicka) (4), one on polystyrene (with Thomas Midgley Jr. of tetraethyllead and CFC fame) (6), and two on organic fluorine compounds (with Albert L. Henne) (8, 11).

While at Ohio State University, Henry found a complete set of the *Journal of the Russian Physico-Chemical Society*, which aroused his interest in the lives and works of Russian chemists, an area in which he became the undisputed American authority. He corresponded actively with colleagues in the Soviet Union, and he amassed a unique collection of Russian books on the history of science, which he later donated to the Stanford Library. In 1971, when I attended the XIIIth International Congress of the History of Science in Moscow, all the Russians asked where Henry was, and it was then that I was surprised to

learn that he had never visited the Soviet Union.

His first contribution to the history of chemistry, a study of Aleksandr Mikhailovich Butlerov, a pioneer in structural organic chemistry (12), was the first of his 17 articles in the *Journal of Chemical Education* (12-14, 18, 19, 23, 29, 32, 33, 36, 39, 46, 50, 61, 65, 73, 88), all but six on Russian chemists such as Butlerov (12, 65), Nikolai Nikolaevich Zinin (13), Vladimir Vasil'evich Markovnikov (14), Tobias Lowitz (19), Max Abramovich Blokh (23), Dmitri Ivanovich Mendeleev (33,61), Germain Henry Hess (50), and Mikhail Vasil'evich Lomonosov (88). Henry served as a member of the journal's Editorial Board from 1949 to 1959. He also contributed biographies of Lomonosov (69), Butlerov (70), and Mendeleev (71) to 1964 Dexter awardee Eduard Farber's *Great Chemists* (Interscience: New York, 1961). In 1962 he received the Seventh Dexter Award in the History of Chemistry; his acceptance address was entitled "Some Aspects of the History of Chemistry in Russia" (73).

In 1941 Henry began his permanent association with the College of Physicians and Surgeons, San Francisco (now the Dental School of the University of the Pacific), where he was Professor of Biochemistry, a position that he held until his retirement in 1977. He served as Chairman of the Department of Physiology and the Department of Biochemistry and as Head of the Research Program, and he was honored for excellence in teaching in 1972. Since the 1940s he was active



Henry Marshall Leicester (1906-1991)

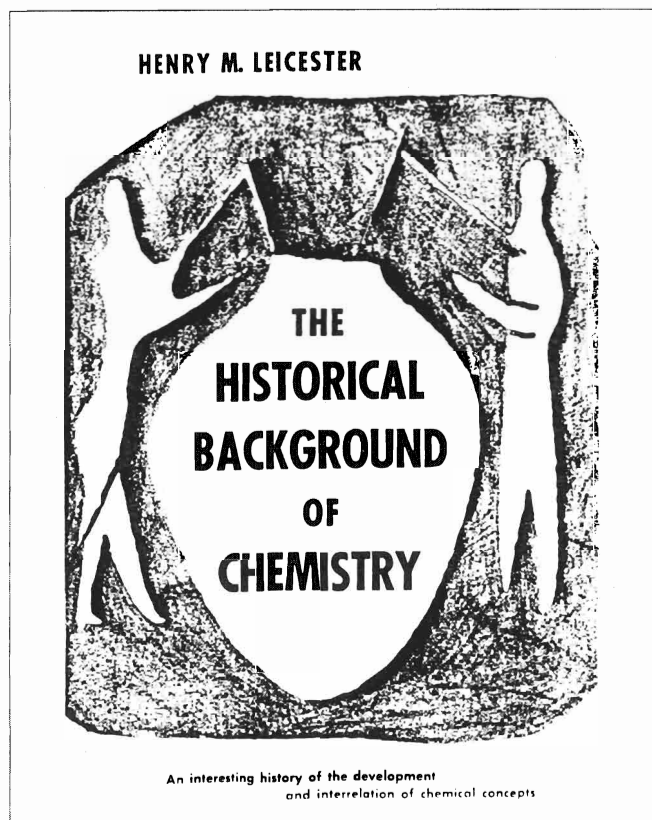

in the American Chemical Society's Division of History of Chemistry, presenting numerous papers, serving as Chair (1947-1951), and being involved in divisional affairs until his retirement. He was one of the founders and a member of the Editorial Board of *Chymia: Annual Studies in the History of Chemistry*, to which he contributed four articles. These dealt with Mendeleev and the periodic law (31), a biographical tribute to Tenney L. Davis (with longtime friend Herbert S. Klickstein) (42), the spread of Lavoisier's "new chemistry" in Russia (63), and biochemical concepts among the ancient Greeks (68). He served as Editor-in-Chief for Volumes 3 (1950) through 12 (1967), the final volume of this journal in book format.

Henry was the author, editor, or translator of seven books, several of which I have been privileged to review - *Biochemistry of the Teeth* (35) - the standard textbook on the subject for two decades; *A Source Book in Chemistry 1400-1900* - with Herbert S. Klickstein (51); *The Historical Background of Chemistry* (57) - his most popular book; *Discovery of the Elements*, 7th ed. (85); *Source Book in Chemistry, 1900-1950* (86); *Mikhail Vasil'evich Lomonosov on the Corpuscular*

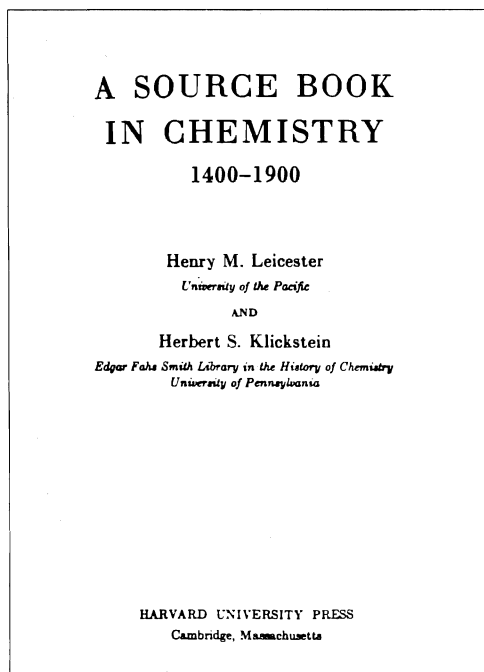

Theory (89); and *Development of Biochemical Concepts from Ancient to Modern Times* (104).

Henry also contributed one article to *Collier's Encyclopedia Americana* (74), seven articles to the *Encyclopaedia Britannica* (76-82), 21 biographies to the *Dictionary of Scientific Biography* (1970-1978) (90-99, 101-103, 105, 106, 108, 116-118, 121, 122), seven biographies to Wyndham Miles' *American Chemists and Chemical Engineers* (109-115), and a

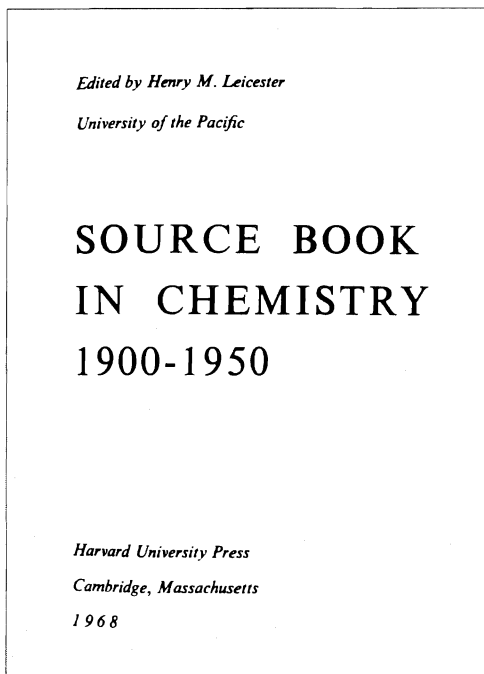

number of articles to the *Academic American Encyclopedia* (124, 125) and other books (45, 58, 60, 66, 83). In addition to his historical studies, he was an authority on caries (16, 17, 25, 26, 40, 43, 44, 48, 59) and the biochemistry of teeth (21, 24, 28, 52, 53, 56, 62, 75). An active advocate of water fluoridation (20, 37, 54) during the 1950s and 1960s, he traveled around California to speak on the subject at community meetings. He was the author of a book (89) and eight articles on Lomonosov (69, 72, 84, 88, 100, 107, 119, 126); the last of his 118 articles, "The Scientific Poetry of Lomonosov," appeared in 1987 (126).

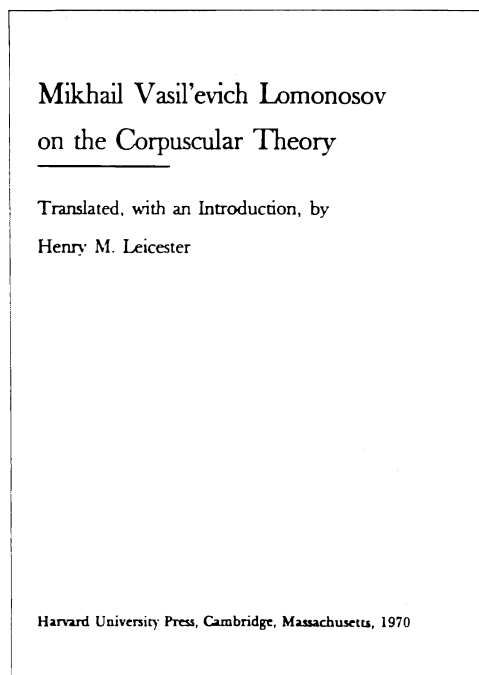

A patient, tolerant, and easily approachable man with a delightful sense of humor, Henry bore his immense erudition without a trace of pretentiousness. During the more than three decades that I knew him, I had numerous occasions to make use of his expertise. As a young novice in the history of chemistry, before embarking on my study of Alfred Werner and coordination chemistry in the early 1960s, I consulted Henry about the feasibility of my project, and I benefited greatly from his sage advice and warm encouragement. When I needed an English translation of Il'ya Il'ich Chernyaev's long article on the trans effect for Volume 3 of my *Classics in Coordination Chemistry, Part III* (123), I naturally turned to Henry and was delighted with the result (pp. 151-195). And before beginning an article on Lomonosov (*J. Chem. Educ.* 1988, 65, 953), I asked Henry for reprints of his pertinent papers, for he was the universally acknowledged American expert on this founder of Russian science.

In 1941 Henry married Leonore Azevedo (1914-1974), whom he had met at the International Students' House at

Stanford (both were members of the Stanford International Club). Their interest in people from other lands endured throughout their 33-year marriage. They participated in pot-luck dinners for international guests, and they took Chinese lessons together. Henry had taken courses in Russian while still a student, and Leonore took Spanish lessons. The couple went folk dancing every Friday night with a group of close friends. Henry was fond of travel, and he took his family on trips through the United States as well as to Canada, Alaska, Australia, New Zealand, and Hawaii. After his retirement he made a trip around the world with his younger daughter.

Never an extrovert and somewhat shy, Henry, nevertheless, loved teaching and interacting with young people, and he and his wife opened their home to friends, guests, colleagues, and students. After his retirement he presided over a rather unusual household of one very imperious cat (named Amy after Amelia Earhart because she fearlessly liked to sit on shoulders and high places), various comings and goings of his children, and a series of boarders and later, caregivers and companions who became part of his extended family. During this time he took walks, built intricate paper models, arranged photograph albums, read science fiction and mysteries, planted flowers, tended his garden, and enjoyed good food and trips to the California coast. He is survived by his children - Henry M. Leicester, Jr. (b. 1942), Professor of Literature at the University of California, Santa Cruz; Martha (b. 1950), a superintendent with the National Park Service; and Margaret ("Guida") (b. 1957), a communications consultant, who cared for her father during his final years. His legacy endures in the hearts and minds of his students, colleagues, friends, and family and in his books and articles that have enriched the science of chemistry and its history.

A Bibliography of the Publications of Henry Marshall Leicester

1929 - 1939

1. "Salts of Triphenyl Selenonium Hydroxide" (with F. W. Bergstrom), *J. Am. Chem. Soc.*, **1929**, *51*, 3587-3591.
2. "Salts of the Toly and Mixed Phenyl Toly Selenonium Hydroxides" (with F. W. Bergstrom), *J. Am. Chem. Soc.*, **1931**, *53*, 4428-4436.
3. "The Isolation of Carotene" (with Harry N. Holmes), *J. Am. Chem. Soc.*, **1932**, *54*, 716-720.
4. "Polyterpene and Polyterpenoide. LXXXVII. Dehydrierung des Betulins. Abbaueversuche in der Allobetulin- und Dihydrobetulinreihe. Inhaltsstoffe der Betulinrinde" (with L. Ruzicka, G. F. Frame, M. Liguori, and H. Brünger), *Helv. Chim. Acta*, **1934**, *17*, 426-442.
5. "The Reactions between Mercury Diaryls and Diaryl Selenium Dihalides", *J. Am. Chem. Soc.*, **1935**, *57*, 1901-1902.
6. "Natural and Synthetic Rubber. XVI. The Structure of

Development of Biochemical Concepts from Ancient to Modern Times

Henry M. Leicester

Harvard University Press
Cambridge, Massachusetts
1974

Polystyrene" (with Thomas Midgley, Jr. and Albert L. Henne), *J. Am. Chem. Soc.*, **1936**, *58*, 1961-1963.

7. "The Reactions between Mercury Diaryls and Selenium Tetrabromide", *J. Am. Chem. Soc.*, **1938**, *60*, 619-620.

8. "Fluorinated Derivatives of Methane Bearing Phenyl Groups" (with Albert L. Henne), *J. Am. Chem. Soc.*, **1938**, *60*, 864-865.

9. "Diphenyl Selenide", *Org. Syn.*, **1938**, *18*, 27-29.

10. "Diphenyl Selenium Dichloride and Triphenyl Selenonium Chloride", *Org. Syn.*, **1938**, *18*, 30-32.

11. "Aliphatic Difluorides" (with Albert L. Henne and Mary Renoll), *J. Am. Chem. Soc.*, **1939**, *61*, 938-940.

1940 - 1949

12. "Alexander Mikhailovich Butlerov", *J. Chem. Educ.*, **1940**, *17*, 203-209.

13. "N. N. Zinin, An Early Russian Chemist", *J. Chem. Educ.*, **1941**, *17*, 303-306.

14. "Vladimir Vasil'evich Markovnikov", *J. Chem. Educ.*, **1941**, *18*, 53-57.

15. "Effects of Sodium Bisulfite in Local Anesthetic Solutions" (with M. L. Tainter and A. H. Thronson), *J. Am. Dent. Assn.*, **1941**, *28*, 1604-1613.

16. "Experimental Studies on Caries. I. A Technic for Cleaning Teeth" (with Harvey M. Schamp), *J. Am. Dent. Assn.*, **1942**, *29*, 1649-1651.

17. "Experimental Studies on Caries. II. A Rat Caries Index" (with Harvey M. Schamp), *J. Am. Dent. Assn.*, **1943**, *30*, 1046-1051.

18. "The New Almaden Mine, The First Chemical Industry in California", *J. Chem. Educ.*, **1943**, *20*, 235-238; published separately,

College Park, MD, 1943.

19. Tobias Lowitz - Discoverer of Basic Laboratory Methods", *J. Chem. Educ.*, **1945**, *22*, 149-151.

20. "Backgrounds of Fluorine Therapy in Dentistry", *J. Calif. State Dent. Assn.*, **1946**, *22*, 73-76, 103-104.

21. "Chemical Changes in the Teeth after Eruption" *J. Am. Dent. Assn.*, **1946**, *33*, 1004-1011.

22. "Dental Journalism Twenty-Five Years Ago", *J. Am. Coll. Dentists*, **1946**, *13*, 112-114.

23. "Max Abramovich Blokh. His Contributions to the History of Chemistry" (with Herbert S. Klickstein), *J. Chem. Educ.*, **1946**, *23*, 451-453.

24. "The Biochemistry of Teeth", *Ann. Rev. Biochem.*, **1946**, *15*, 361-374.

25. "The Effect of Cadmium on the Production of Caries in the Rat", *J. Dent. Research*, **1946**, *25*, 337-340.

26. "Recent Developments in the Treatment of Dental Caries", *Stanford Med. Bull.*, **1947**, *5*, 8-12.

27. "Philately - A Chapter in the History of Chemistry" (with H. S. Klickstein), *J. Hist. Med.*, **1947**, *2*, 237-278.

28. "Amelogenesis. An Integration of the Known Factors Concerned with the Development, Formation, and Mineralization of Enamel" (with James Nuckolls and Benjamin Dienst), *J. Am. Coll. Dentists*, **1947**, *14*, 118-153.

29. "The History of Chemistry in Russia Prior to 1900", *J. Chem. Educ.*, **1947**, *24*, 438-443.

30. "Charles Albert Browne, 1870-1947", *The Register of Phi Lambda Upsilon*, **1948**, *33*, 56-58.

31. "Factors Which Led Mendeleev to the Periodic Law", *Chymia*, **1948**, *1*, 67-74.

32. "Charles Albert Browne as an Historian of Chemistry" (with Herbert S. Klickstein), *J. Chem. Educ.*, **1948**, *25*, 315-317, 343.

33. "Mendeleev and the Russian Academy of Sciences", *J. Chem. Educ.*, **1948**, *25*, 439-441.

34. "Interrelations between Chemistry and World History", *The Vortex*, **1949**, *10*, 32-40.

35. *Biochemistry of the Teeth*, C. V. Mosby Co., St. Louis, MO, 1949 (book).

36. "Chemistry in Early California", *J. Chem. Educ.*, **1949**, *26*, 403-406.

37. "Fluorine - The New Hope", *California Parent-Teacher*, **1949**, July-Aug., 6-7, 32.

1950 - 1959

38. "A Suggestion for the Standardization of Dental Nomenclature", *J. Calif. State Dent. Assn.*, **1950**, *26*, 74-75.

39. "Tenney L. Davis and His Work in the History of Chemistry" (with Herbert S. Klickstein), *J. Chem. Educ.*, **1950**, *27*, 222-224.

40. "Introduction and Summary to the Symposium, Sugar and Dental Caries", *J. Calif. State Dent. Assn.*, **1950**, *26*(3), Supplement, 5-6.

41. "The Application of Biochemical Methods to Dental

Research", *J. Am. Dent. Assn.*, **1950**, *41*, 169-172.

42. "Tenney Lombard Davis and the History of Chemistry" (with Herbert S. Klickstein), *Chymia*, **1950**, *3*, 1-16.

43. "Caries Research: Its Present Position and Future Trends", *J. Am. Coll. Dentists*, **1950**, *17*, 376-379; reprinted in *J. Calif. State Dent. Assn.*, **1951**, *27*, 75-76, 87.

44. "The Mechanism of Recent Methods for Caries Control", *Dent. J. Australia*, **1950**, *22*, 619-624.

45. "History of Chemistry", *Ind. Eng. Chem.*, **1951**, *43*, 1053-1056; reprinted in *Chemistry - Key to Better Living*, American Chemical Society, Washington, DC, 1951, pp. 173-176.

46. "Dumas, Davy, and Liebig", *J. Chem. Educ.*, **1951**, *28*, 352-354.

47. "A Tracer Study of Distribution of Iodoacetate in Fat Tissues" (with Paul H. Thomassen), *Proc. Soc. Exper. Biol. Med.*, **1951**, *77*, 622-624.

48. "Mecanismo de la caries y su prevención", *A. D. M. Rev. Ass. Dental Mexicana*, **1951**, *8*, 227-232.

49. "Applied Science in Chemical Industry", *Am. J. Pharmaceutical Educ.*, **1951**, *15*, 308-318.

50. "Germain Henry Hess and the Foundations of Thermochemistry", *J. Chem. Educ.*, **1951**, *28*, 581-583.

51. *A Source Book in Chemistry 1400-1900* (with Herbert S. Klickstein), McGraw-Hill, New York, 1952; Harvard University Press, Cambridge, MA, 1963 (book, edited).

52. "The Biochemistry of the Teeth", *Ann. Rev. Biochemistry*, **1953**, *22*, 341-350.

53. "Biochemistry of Teeth", *J. Applied Nutrition*, **1953**, *6*, 279-281.

54. "Water Fluoridation Forum", *J. Applied Nutrition*, **1953**, *6*, 294-295.

55. "Dentistry", *Ann. Rev. Medicine*, **1954**, *5*, 405-414.

56. "Nutrition and the Teeth", *J. Am. Dent. Assn.*, **1956**, *52*, 284-289; *J. Am. Osteopath. Assn.*, **1956**, *55*, 45-50.

57. *The Historical Background of Chemistry*, Wiley, New York, 1956; paperback ed., 1965; Hebrew transl., Tel Aviv, 1966; Spanish transl., Madrid, 1967; Dover paperback ed., New York, 1971; Italian transl., Milan, 1980; Japanese transl., Tokyo, 1981 (book).

58. "Elements Discovered by Atomic Bombardment", in M. E. Weeks, *Discovery of the Elements*, 6th ed., Easton, PA, 1956, pp. 859-885.

59. "Recent Methods for the Prevention of Dental Caries", *J. Chem. Educ.*, **1957**, *54*, 96-98; *J. Calif. State Dental Assn.*, **1957**, *35*, 190-192; reprinted in W. F. Kieffer and R. K. Fitzgerald, eds., *Selected Readings in General Chemistry*, Journal of Chemical Education, Easton, PA, 1959, pp. 18-20.

60. "Atoms, Molecules and Reactions: Books on Chemistry" in *The First One Hundred and Fifty Years. A History of John Wiley and Sons, Inc.*, Wiley, New York, 1957, pp. 43-50.

61. "Mendeleev's Visit to America", *J. Chem. Educ.*, **1957**, *35*, 381-383.

62. "The Mineral Metabolism of Bones and Teeth", *J. Applied Nutrition*, **1957**, *10*, 478-481.

63. "The Spread of the Theory of Lavoisier in Russia", *Chymia*, **1959**, 5, 139-144.
64. "Recent Russian Research in Metabolism and Endocrinology", *Ann. Rev. Physiology*, **1959**, 21, 475-498.
65. "Contributions of Butlerov to the Development of Structural Theory", *J. Chem. Educ.*, **1959**, 36, 328-329; reprinted in A. J. Ihde and W. F. Kieffer, eds., *Selected Readings in the History of Chemistry*, Journal of Chemical Education, Easton, PA, 1965, pp. 245-246.
66. "Chemistry of Specialized Tissues", "Digestion", and "Urine", in J. C. Muhler, ed., C. V. Mosby, St. Louis, MO, 1959, pp. 128-143, 159-168, 313-317; 2nd ed., 1964, pp. 141-156, 174-183, 338-343.
- 1960 - 1969**
67. "Chemistry, Chemical Technology, and Scientific Progress", *Technology and Culture*, **1961**, 2, 352-356.
68. "Biochemical Concepts Among the Ancient Greeks", *Chymia*, **1961**, 7, 9-35.
69. "Mikhail Vasil'evich Lomonosov", in E. Farber, ed., *Great Chemists*, Interscience, New York, 1961, pp. 201-210.
70. "Alexander Mikhailovich Butlerov", in E. Farber, ed., *Great Chemists*, Interscience, New York, 1961, pp. 687-696.
71. "Dmitri Ivanovich Mendeleev", in E. Farber, ed., *Great Chemists*, Interscience, New York, 1961, pp. 717-732.
72. "Znakomstvo Uchenykh Severnoi Ameriki Kolonial'nogo Perioda s Rabotami M. V. Lomonosova i Peterburgskoi Akademii Nauk" (Knowledge of the Work of Lomonosov and the Academy of Sciences in Colonial North America), *Voprosy Istorii Estestvoznaniya i Tekhniki*, **1962**, 12, 142-147.
73. "Some Aspects of the History of Chemistry in Russia" (1962 Dexter Award Address), *J. Chem. Educ.*, **1963**, 40, 108-109; reprinted in A. J. Ihde and W. F. Kieffer, eds., *Selected Readings in the History of Chemistry*, Journal of Chemical Education, Easton, PA, 1965, pp. 47-48.
74. "History of Chemistry", in *Colliers Encyclopedia Americana*, P. F. Collier, New York, 1963 ed., Vol. 6, pp. 401-408.
75. "Uptake of Radioactive Beryllium, Vanadium, Selenium, Cerium, and Yttrium in the Tissues and Teeth of Rats:", (with Paul R. Thomassen), *J. Dental Research*, **1964**, 43, 346-352.
76. "Alchemy", in *Encyclopaedia Britannica*, 1964 ed., Chicago, IL, Vol. 1, pp. 534-537.
77. "History of Chemistry", in *Encyclopaedia Britannica*, 1964 ed., Chicago, IL, Vol. 5, pp. 388-394.
78. "Geber", in *Encyclopaedia Britannica*, 1964 ed., Chicago, IL, Vol. 10, p. 46.
79. "Nernst", in *Encyclopaedia Britannica*, 1964 ed., Chicago, IL, Vol. 16, pp. 229-230.
80. "Kekulé von Stradonitz", in *Encyclopaedia Britannica*, 1965 ed., Chicago, IL, Vol. 13, pp. 270-271.
81. "Liebig", in *Encyclopaedia Britannica*, 1965 ed., Chicago, IL, Vol. 13, pp. 1077-1078.
82. "Ostwald", in *Encyclopaedia Britannica*, 1965 ed., Chicago, IL, Vol. 16, pp. 1151-1152.
83. "Kekulé, Butlerov, Markovnikov: Controversies on Chemical Structure from 1860 to 1870", in O. T. Benfey, ed., *Kekulé Centennial*, Advances in Chemistry Series No. 61, American Chemical Society, Washington, DC, 1966, pp. 13-23.
84. "Boyle, Lomonosov, Lavoisier, and the Corpuscular Theory of Matter", *Isis*, **1967**, 58, 240-244.
85. M. E. Weeks, *Discovery of the Elements*, 7th ed., completely revised and new material added by H. M. Leicester, Journal of Chemical Education, Easton, PA, 1968 (book).
86. *Source Book in Chemistry, 1900-1950*, Harvard University Press, Cambridge, MA, 1968 (book, edited).
87. "Chemistry Requirements for the Dental School", *Proc. Two-Year College Chemistry Conference, 1967-1968 Academic Year*, pp. 36-37.
88. "Mikhail Lomonosov and the Manufacture of Glass and Mosaics", *J. Chem. Educ.*, **1969**, 45, 295-298.
- 1970 - 1979**
89. *Mikhail Vasil'evich Lomonosov on the Corpuscular Theory*, Harvard University Press, Cambridge, MA, 1970 (book translation and introduction).
90. "Berzelius, Jöns Jacob", in C. C. Gillispie, ed., *Dictionary of Scientific Biography*, Scribner's, New York, 1970, Vol. 2, pp. 90-97.
91. "Cannizzaro, Stanislao", in C. C. Gillispie, ed., *Dictionary of Scientific Biography*, Scribner's, New York, 1971, Vol. 3, pp. 45-49.
92. "Clark, William Mansfield", in C. C. Gillispie, ed., *Dictionary of Scientific Biography*, Scribner's, New York, 1971, Vol. 3, p. 290.
93. "Deville, Henri Etienne Sainte-Claire", in C. C. Gillispie, ed., *Dictionary of Scientific Biography*, Scribner's, New York, 1971, Vol. 4, pp. 77-78.
94. "Fittig, Rudolph", in C. C. Gillispie, ed., *Dictionary of Scientific Biography*, Scribner's, New York, 1972, Vol. 5, pp. 12-13.
95. "Folin, Otto", in C. C. Gillispie, ed., *Dictionary of Scientific Biography*, New York, 1972, Vol. 5, p. 53.
96. "Hess, Germain Henri", in C. C. Gillispie, ed., *Dictionary of Scientific Biography*, Scribner's, New York, 1972, Vol. 6, pp. 353-354.
97. "Jones, Harry Clary", in C. C. Gillispie, ed., *Dictionary of Scientific Biography*, Scribner's, New York, 1973, Vol. 7, pp. 161-172.
98. "Kolbe, Adolph Wilhelm Hermann", in C. C. Gillispie, ed., *Dictionary of Scientific Biography*, Scribner's, New York, 1973, Vol. 7, pp. 450-453.
99. "Kopp, Hermann", in C. C. Gillispie, ed., *Dictionary of Scientific Biography*, Scribner's, New York, 1973, Vol. 7, pp. 463-464.
100. "The Electrical Theories of M. V. Lomonosov", *Ann. Sci.*, **1973**, 30, 299-310.
101. "Lebedev, Sergei Vasilievich", in C. C. Gillispie, ed., *Dictionary of Scientific Biography*, Scribner's, New York, 1973, Vol. 8, p. 108.

102. "Le Bel, Joseph Achille", in C. C. Gillispie, ed., *Dictionary of Scientific Biography*, Scribner's, New York, 1973, Vol. 8, pp. 109-110.
103. "Le Châtelier, Henry Louis", in C. C. Gillispie, ed., *Dictionary of Scientific Biography*, Scribner's, New York, 1973, Vol. 8, pp. 116-120.
104. *Development of Biochemical Concepts from Ancient to Modern Times*, Harvard University Press, Cambridge, MA, 1974 (book).
105. "Muir, Matthew Moncrieff Pattison", in C. C. Gillispie, ed., *Dictionary of Scientific Biography*, Scribner's, New York, 1974, Vol. 9, p. 557.
106. "Müller, Paul", in C. C. Gillispie, ed., *Dictionary of Scientific Biography*, Scribner's, New York, 1974, Vol. 9, pp. 576-577.
107. "Lomonosov's Views on Combustion and Phlogiston", *Ambix*, **1975**, 22, 1-9.
108. "Sørensen, Søren Peter Lauritz", in C. C. Gillispie, ed., *Dictionary of Scientific Biography*, Scribner's, New York, 1975, Vol. 12, pp. 546-547.
109. "James Blake", in Wyndham Miles, ed., *American Chemists and Chemical Engineers*, American Chemical Society, Washington, DC, 1976, p. 36.
110. "Tenney Lombard Davis", in Wyndham Miles, ed., *American Chemists and Chemical Engineers*, American Chemical Society, Washington, DC, 1976, pp. 112-113.
111. "Edward Curtis Franklin", in Wyndham Miles, ed., *American Chemists and Chemical Engineers*, American Chemical Society, Washington, DC, 1976, pp. 158-159.
112. "Gilbert Newton Lewis", in Wyndham Miles, ed., *American Chemists and Chemical Engineers*, American Chemical Society, Washington, DC, 1976, pp. 296-297.
113. "Harry Wheeler Morse", in Wyndham Miles, ed., *American Chemists and Chemical Engineers*, American Chemical Society, Washington, DC, 1976, pp. 350-351.
114. "Willard Bradley Rising", in Wyndham Miles, ed., *American Chemists and Chemical Engineers*, American Chemical Society, Washington, DC, 1976, pp. 410-411.
115. "John Maxon Stillman", in Wyndham Miles, ed., *American Chemists and Chemical Engineers*, American Chemical Society, Washington, DC, 1976, pp. 457-458.
116. "Virtanen, Artturi Ilmari", in C. C. Gillispie, ed., *Dictionary of Scientific Biography*, Scribner's, New York, 1976, Vol. 14, pp. 45-46.
117. "Wallach, Otto", in C. C. Gillispie, ed., *Dictionary of Scientific Biography*, Scribner's, New York, 1976, Vol. 14, pp. 141-142.
118. "Windaus, Adolf Otto Reinhold", in C. C. Gillispie, ed., *Dictionary of Scientific Biography*, Scribner's, New York, 1976, Vol. 14, pp. 443-446.
119. "The Geochemical Ideas of Mikhail Lomonosov", *Ann. Sci.*, **1976**, 33, 341-350.
120. "The Mystique of Vitamins", *Scientia*, **1977**, 112, 361-370.
121. "Fischer, Hans", in C. C. Gillispie, ed., *Dictionary of Scientific Biography*, Scribner's, New York, 1978, Vol. 15, pp. 157-158.
122. "Karrer, Paul", in C. C. Gillispie, ed., *Dictionary of Scientific Biography*, Scribner's, New York, 1978, Vol. 15, pp. 257-258.
123. Translation of I. I. Chernyaev, "The Theory of Complex Compounds: Article I", in G. B. Kauffman, ed., *Classics of Coordination Chemistry, Part III: Twentieth Century Papers (1904-1935)*, Dover, New York, NY, 1978, pp. 151-152.
- 1980 - 1989**
124. "Electron Configuration", in *Academic American Encyclopedia*, Aretê, Princeton, NJ, 1980, Vol. 7, p. 120.
125. "Periodic Table", in *Academic American Encyclopedia*, Aretê, Princeton, NJ, 1980, Vol. 15, pp. 166-169; and a number of short biographical notes scattered throughout the various volumes.
126. "The Scientific Poetry of Lomonosov", in H. M. Said, ed., *Essays on Science: Felicitation Volume in Honour of Dr. S. Mahdihassan*, Hamdard Foundation, Karachi, Pakistan, 1987, pp. 167-173.
-
- Dr. George B. Kauffman is Professor of Chemistry at California State University - Fresno, Fresno, CA 93740. A Past Chair of the Division and recipient of the 1978 Dexter Award, he is the author of 15 books and more than 970 papers, reviews, and encyclopedia articles on chemistry; chemical education; and the history of chemistry, science, and technology.*
-
- ## SOME EDGAR FAHS SMITH MEMORABILIA
- William D. Williams, Harding University*
- Edgar Fahs Smith is recognized as the Dean of American chemical historians. His papers and books have inspired many of us to study early chemistry. His influence in establishing the Division of the History of Chemistry of the American Chemical Society has promoted research in that field and his wonderful collection of early chemical books, portraits and memorabilia, still housed at the University of Pennsylvania, has preserved for all of us a tangible and irreplaceable link with our professional past.
- I certainly cut my history-of-chemistry teeth on Smith's works and have tried to emulate his writing and collecting. In this process, I became a close friend of Wyndham Miles, another chemical historian and "old chemistry" collector. Dr. Miles has spent 40 years supplementing Smith's work on early American chemistry. Over the years he has accumulated a large rare chemistry collection, including some interesting Smith memorabilia. As a regular visitor to the Smith Collection, Miles became well known to Eva Armstrong and Robert Sutton, who were its curators. In the 1950s, when the Smith

Collection was discarding some duplicate volumes and some of E. F. Smith's non-chemistry books, Miles obtained them for his collection. When Miles retired in 1984, he placed his collection and research files at Harding University, to be combined with mine.

So here I am, searching through third and fourth-hand material for fragments that contain insights into the character of Edgar F. Smith. Just as I enjoyed reading the recent story about the Smith statue on the University of Pennsylvania campus (1), perhaps you will be interested in some of this memorabilia. Join me and let's see what we can find!

The first item to come to hand is a presentation copy of Smith's *Old Chemistries*, with the inscription: "To Dr. Tenney L. Davis, whose love for ancient chemical literature endears him to thousands of chemistry students - from one of them, The Author." Davis was, of course, another of the founders of the Division of the History of Chemistry and also an avid student of early American chemistry.

In another copy of the same book, we find a letter from Smith which traces its surprising bibliographic success:

University of Pennsylvania
Philadelphia
Edgar F. Smith

January thirtieth 1928

Dear Mr. Marshall:

I have your letter of January 28th. I am exceedingly sorry but it is

January thirtieth
1928

Dear Mr. Marshall:

I have your letter of January 28th. I am exceedingly sorry but it is impossible to get a copy of my little book entitled "Chemistry in Old Philadelphia." The edition was 500, I think. The book disappeared rapidly. I handled it myself, as the publishers evidently did not think that it would sell very well. They seemed surprised when it was taken up so heartily.

Do you happen to have another volume of mine entitled "Chemistry in America?" There is undoubtedly a copy of that in the library in Baltimore.

Yours sincerely,

Edgar F. Smith



Edgar Fahs Smith

impossible to get a copy of my little book entitled "Chemistry in Old Philadelphia." The edition was 500, I think. The book disappeared rapidly. I handled it myself, as the publishers evidently did not think that it would sell very well. They seemed surprised when it was taken up so rapidly.

Do you happen to have another volume of mine entitled "Chemistry in America?" There is undoubtedly a copy of that in the library in Baltimore.

Yours sincerely,
Edgar F. Smith [signed]

To Mr. A. E. Marshall
3034 St. Paul St.
Baltimore, MD

A box of books that once belonged to Dr. Smith, many with his signature in them, reveals an unrecorded facet of his busy life. It contains a collection of 43 western and civil war novels by the same author, Captain Charles King. Similar in content and period to those of Zane Grey, these stories were drawn from King's experiences as an Army Cavalry officer in the 1870s (2). A graduate and former teacher at West Point, King had been stationed among the Apaches in the Tonto Basin of Northern Arizona Territory. He was among troops who made a 2000 mile march through the Big Horn region to disperse the Sioux Indians following "Custer's Last Stand". On multiple occasions he had engaged in mortal combat with Indians. He was a friend of "Buffalo Bill" Cody, who was a scout for his Company. King's writing was rich in authentic frontier and Army life. Using different names and circumstances, he wove into his stories the characters he had met, his love for horses,

and even his own serious wounding at the hands of the Apaches.

Smith's enjoyment of Captain King's books is attested by an envelope tucked into one of them. It contained a letter and autographed photo from Charles King to Smith. The photo shows King, at age 81, ramrod straight and immaculately uniformed, astride a handsome horse. It is inscribed: "To Prof. Edgar F. Smith, with the regards of Charles King, 1925". The reverse of the photo proudly explains:

Star and C. K. Combined ages 98 years. Winner of the Blue Ribbon (1st prize), Annual Horse Show, State Fair, Milwaukee, Wis. Sept 25. Officers Charges Class Ten Competition.

The letter is a poignant tribute to the character of both of these men as they neared the end of their lives:

St. Johns Military Academy
Delafield, Wis
September 26, 1925

My dear Sir:

Not in many a moon have I received a letter which gave me such pleasure as yours of the 21st inst. It is a rare thing that men of your



Charles King

high standing in the Educational world find time to read such work as mine, much less to attach to it any value whatsoever, and I thank you with a full heart for every word of it ... That letter goes in a special file for my grandson and namesake, and should I be able to come East next June to attend the sixtieth anniversary of the graduation of my class at West Point, I shall do myself the honor of looking you up at the University.

The estimate placed by publishers on these frontier stories of long ago differs so widely from yours that the most valuable from a historical point of view, "Campaigning with Crook," the story of the great Sioux War of 1876, has been allowed by Harper & Brothers to go out of print ...

Gratefully & Sincerely yours, Charles King

Prof. Edgar F. Smith

In yet another box is a book describing Smith's participation in a stage presentation at the Philadelphia Academy of Music on 29 April 1914. It was a gala evening with a packed house of the city's finest. Proceeds were designated to aid local hospitals. The program, entitled "Trial of John Jasper for the Murder of Edwin Drood," was a somewhat extemporaneous mock trial based upon an unfinished novel by Charles Dickens. When Dickens died in 1870, six installments of his *The Mystery of Edwin Drood* had been published. Evidence

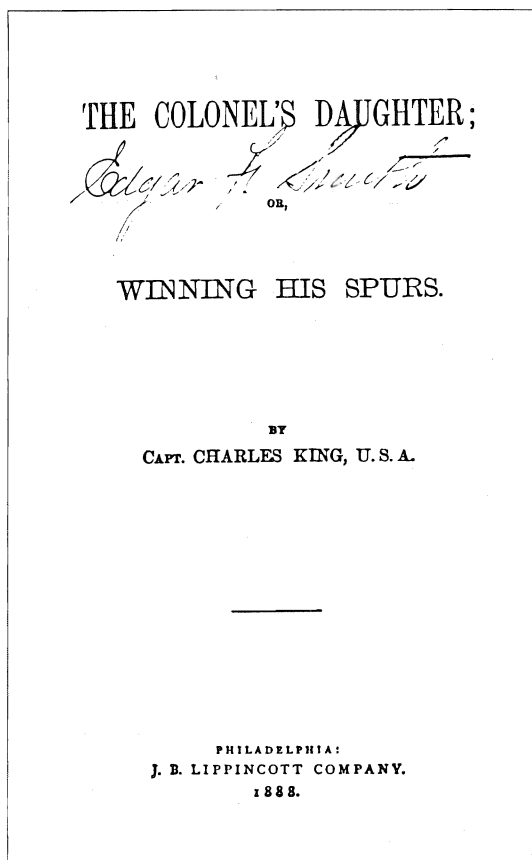

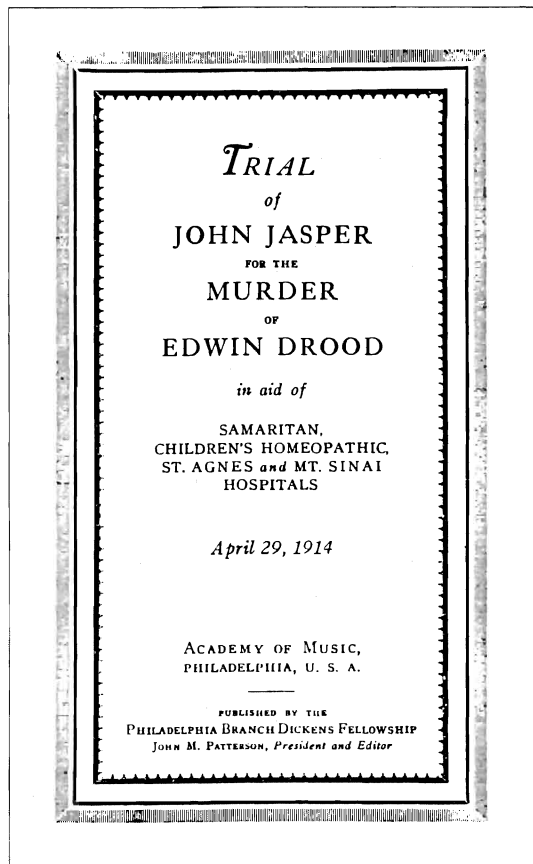

pointed to multiple suspects for the disappearance and supposed murder of Drood, but not even an outline of Dickens' conclusion was found. Other authors tried to finish the story but all versions were unsatisfying. Finally, British mystery lovers presented a public trial of John Jasper, with Gilbert K. Chesterton as judge and George Bernard Shaw as jury foreman. Following the same format, the Philadelphia version was elaborately staged with Dickensian costumes and a cast of eminent judges, politicians and civic leaders.

Edgar F. Smith served as a member of the jury. His selection to be seated illustrates the tongue-in-cheek nature of the evening (3):

CRIER: Juror number seven, Edgar F. Smith

CLERK: Juror, look upon the prisoner; prisoner, look upon the juror. How say you, challenge or no challenge?

DEFENSE: No challenge.

PROSECUTION: I should like to have it noted upon the record that Fate tried to conceal him by naming him Smith. (Laughter)

Q: You are Provost of the great University of this Commonwealth?

A: I am.

Q: I believe that the sun never sets on the sons of Penn? (Applause)

A: That is true.

Q. Did you ever have John Jasper or Edwin Drood enrolled upon the

records of the University? (Laughter)

A: Never, sir.

Q Then I apprehend that the love and partiality that you bear for all the sons of Penn would not obtain in this case?

A It would not.

Q: And you could render an unbiased verdict?

A: I could, sir.

(Juror takes seat in jury box.)

Despite the levity, the trial endeavored to be objective in the evidence and the verdict. The presentation had begun at 7:30, but most of the audience were still in their seats after midnight when the jury returned a "not guilty" verdict. It was reported that the jury was at first deadlocked at six for acquittal and six for guilty. It would be interesting to know what Smith thought and said as the jury deliberated.

Another book from Smith's library carries the title, *Jenghiz Khan and Other Verses*, by Erwin Clarkson Garrett. It contains a poem dedicated to Smith (4):

To Dr. Edgar Fahs Smith upon his retirement as Provost of the University of Pennsylvania, 1920.

We may not bear to think - ye we've always known-
A keystone fair, a comrade rare - should feel the time had grown
To drop the reins your hands have held with master grip -

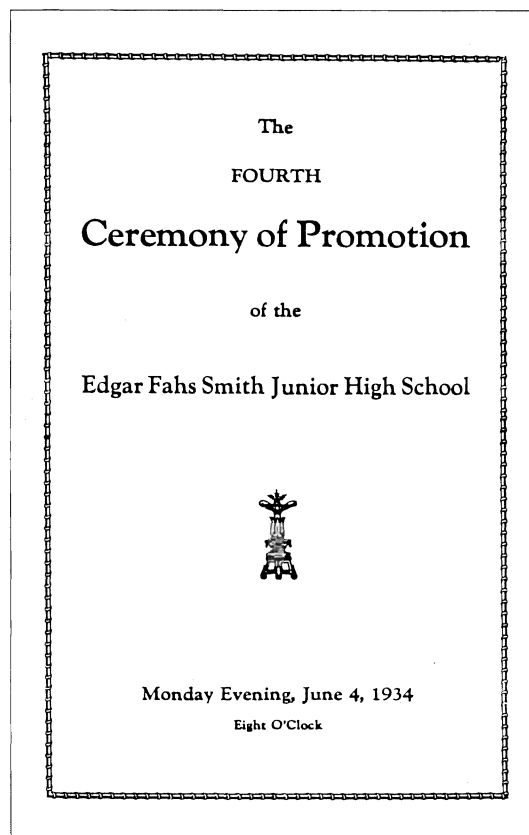

Or quit the straining tiller of your loved and honored ship.

We may not bear to think - ye we've cherished long -

Ye will not stand where ye have watched your mighty craft wax strong.

Deck and deck upbuilding - mast and mast arise -

A source of pride, a cause of joy, in your all seeing eyes.

But though ye go ye never may cut the sacred bands

That bind you to the Sons of Penn through all the far flung lands,

For over hall and campus ye've cast a golden spell -

A gentle knight - a beacon light - Friend of our youth, farewell!!

There are also tattered programs for the 1934 and 1937 graduation exercises at the Edgar Fahs Smith Junior High School at York, PA, the city where Smith was born. The 1937 program celebrated the 150th anniversary of the York County Academy. A yellowed clipping explains (5):

... In celebrating this anniversary we do honor not only to the academy but to its most famous student, the late Edgar Fahs Smith," declared Mr. Kain, who stated that at the 125th anniversary celebration of the founding of the academy, Mr. Smith wanted for the 150th anniversary such a procession of representatives of educational institutions as was presented last night ... Mrs. Edgar Fahs Smith was a special guest of honor last night ...

These fragments, though few in number, reveal the Smith known only to his close friends and family and allow us to glimpse the man behind the name. Only those who have actually handled such artifacts can fully appreciate the power they possess of evoking in the handler a feeling of almost tangible contact with the personality of their long-dead owner.

References and Notes

1. J. Bohning, "The Monster Under Edgar's Foot", *Bull. Hist. Chem.*, **1988**, *1*, 20-22.
2. Two books by King contain biographical material: C. King, *Campaigning with Crook and Stories of Army Life*, Harper & Brothers, New York, 1890, pp. 1-171; C. King, *Dunraven Ranch*, J. B. Lippincott, Philadelphia, 1888, pp. 856-862.
3. J. M. Patterson, ed., *Trial of John Jasper for the Murder of Edwin Drood*, Philadelphia Branch Dickens Fellowship, Philadelphia, 1916, pp. 47-48.
4. E. C. Garrett, *Jenghiz Khan and Other Verses*, John Winston, Philadelphia, 1924, p. 78.
5. *Gazette and Daily*, York, PA, 2 June 1937, p. 1.

William D. Williams is Professor of Chemistry at Harding University, Searcy, AR 72143. He collects and studies early American chemistry texts.

THE HISTORY OF FOOD COLORANTS BEFORE ANILINE DYES

Harold T. McKone, Saint Joseph College

The addition of coloring agents to foods is not a recent phenomenon. In ancient Greece and Rome, wine was often artificially colored and inspectors were appointed to monitor this practice. In the first century A.D., Pliny the Elder comments on the Gallic wine industry as follows (1):

... about the rest of the wines grown in the Province of Narbonne no positive statement can be made, in as much as the dealers have set up a regular factory for the purpose and color them by means of smoke ... a dealer actually uses aloe for adulterating the flavor and color of his wines.

The first recorded "pure food laws" were passed in Europe in the early middle ages. A regulation concerning the adulteration of beer, enacted in 1292 in France stated (2):

Whoever put into beer baye, pimento, or "poix" resine was to be fined 20 francs ... for such things are neither good nor loyal to put into beer, for they are bad for the head and the body, for the healthy and the sick.

Butter was another commonly adulterated food. An Edict of Paris in 1396 prohibited its coloration with flowers, herbs or drugs. In England, bread appears to have been the most commonly adulterated food in the middle ages. As early as 1155, laws were passed regulating its composition, price, and formulation. Punishment for selling adulterated bread was severe (3):

If any default ... be found in the bread of a baker of the city, the first time, let him be drawn upon a hurdle from the Guildhall to his own house, through the greatest streets, where there are most people assembled, and through the streets which are most dirty, the false loaf hanging from his neck.

The great trade expansion of the 16th and 17th centuries brought tea, coffee, chocolate, and spices to Europe. With the influx of these new foods came more skillful methods of adulteration. Tea from China arrived with iron filings, clay, and gypsum to increase weight and mineral salts such as copper sulfate to intensify color. Joseph Addison (1672-1719) comments on the adulteration problem in England in 1710 as follows (4):

There is in this city a certain fraternity of chemical operators who work underground in holes, caverns, and dark retirements ... they can squeeze Bordeaux out of sloe and draw champagne from an apple.

The history of the coloring of tea in 18th century England is

POISON DETECTED:
OR
FRIGHTFUL TRUTHS;

AND
Alarming to the *British Metropolis.*

IN A
TREATISE on BREAD;
AND THE

ABUSES practised in making that FOOD,
As occasioning the decrease and degeneracy of the
people; destroying infants; and producing innumerable
diseases.

SHEWING ALSO
The virtues of GOOD BREAD, and the manner of
making it.

To which is added,
A CHARGE to the confederacy of bakers, corn-dealers,
farmers, and millers; concerning short weight, adul-
terations, and artificial scarcities; with easy methods
to prevent all such abuses.

By MY FRIEND, a Physician.

*If thy brother wants bread, will thou give him a stone?
or if he asks a fish, will thou give him a serpent?*

JESUS CHRIST.

Dicere vix possis haud multi talia plorent. JUVENAL.

LONDON:

Printed for Messrs. DODSLEY, in *Pall-Mall*; OSBORNE,
in *Gray's-Inn*; CORBET, in *Fleet-street*; GRIFFITH, in
Pater-noster-row; and JAMES, at the *Royal Exchange*.

MDCCLVII.

[Price One Shilling and Six-pence.]

particularly interesting. It has already been mentioned that tea imported to England from China contained mineral salts for coloration. In addition, used tea was purchased from hotels and doctored with graphite to add weight and improve texture and with copper salts for coloration prior to repackaging and resale. This practice was so common that, during the reign of George I, a law was passed forbidding the addition of any substance to tea under a penalty of a £100 fine. This act was strengthened under George II in 1730. The preamble of this addition states (5):

... ill-disposed persons do frequently ... color, stain, or dye such leaves and likewise mix tea with *terra japonica*, sugar, molasses, clay, logwood and other ingredients, and so sell and vend the same as true tea, to the prejudice of the health of His Majesty's subjects, the diminution of the revenue, and the ruin of the fair trader.

In 1757, a tract entitled *Poison Detected* authored by "My Friend, a Physician", was published. In this work, the author outlined how tea was colored by copper salts, veal whitened with chalk, beer adulterated with vitriol, and bread contaminated with alum, lime, chalk, and "sacks of old bones". The millers who sold the flour to the bakers were the object of particularly harsh criticism (6):

Cannibals indeed let the body be dead before they devour it. But these savages of a more cruel and impetuous voracity, feast upon the living ... our race of destroyers privily poison the food thro' they prey upon us.

Another pamphlet, published almost simultaneously, "The Nature of Bread, Honestly and Dishonestly Made", discussed the history of the adulteration of flour. The author, Dr. Joseph Manning, outlined the following procedure for detecting contaminants (including white lead) in bread (7):

Cut off the crust from a loaf, and setting it aside cut the crumb into very thin slices. Break these, but not very small, and put them into a glass cucurbit, with a large quantity of water ... the crumb of the bread will in this time soften in all its parts. The alum will dissolve in the water and may be extracted from it in the usual way ... the other ingredients being heavy will sink quite to the bottom ... these (will be) the chalk, bone ashes, and whatever else was used.

To refute allegations of food adulteration, particularly of bread, a group of bakers published a reply in 1758, under the authorship of Emanuel Collins, entitled *Lying Detected*. Although these works added little insight into the growing

LYING DETECTED;

OR, SOME OF THE

Most *frightful* UNTRUTHS
That ever alarmed the *British Metropolis*,
FAIRLY EXPOSED.

Plainly shewing the *Absurdity*, as well as *Villainy*, of
the *false Charges* made on the BAKERS of *London*;
Lately publish'd by One, who (much to the honour of
the Faculty)

Calls HIMSELF ——— A *PHYSICIAN*.
Dedicated with the deepest Respect, to the most wonderful
Dr. MÆVIUS MANNING,

Of *London*, who has patronized and adapted the un-
known Doctor's scheme, to the world's everlasting
Wonder, and his own immortal Honour.

By EMANUEL COLLINS.

Semper bones, nomenque tuum, laudesque manebunt.

Facile est Vitiis altercari—verum, Re vincere Difficile.—
"How easily is it to culminate and falsely charge the
Innocent and Guiltless! but to produce Facts, how
difficult." SENEC.

Thou shalt not bear false Witness against thy Neighbour. EX.

TO THIS IS ADDED,
A DEFENCE
OF THE

MEALMEN, CORNFACTORS, and MILLERS,
Which he has unjustly accused of making a *factitious*
Famine.

THE SECOND EDITION, WITH A SUPPLEMENT.

BRISTOL:

Printed by E. FARLEY and SON, in *Small-Street*,
MDCCLVIII.

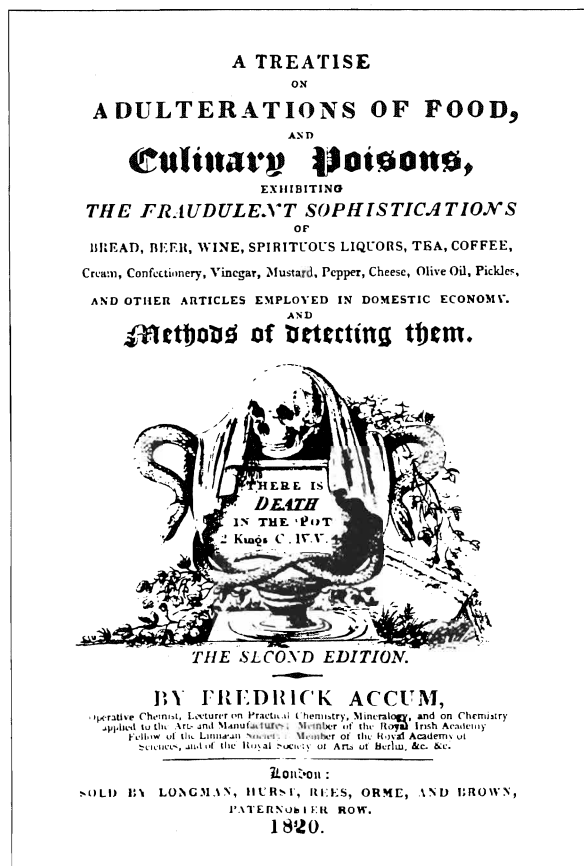

concern and controversy over food adulteration, they provided the foundation for what was to come.

Between 1780 and 1820, there was a definite increase in the incidences of the adulteration of foods with questionable colors. There are at least two reasons for this increase. First, during this time, there was widespread dissemination of trade handbooks and texts of secret recipes that outlined the methodology of adding colorants to foods. Secondly, this period marked the beginnings of modern chemistry. Thus, the color manufacturer and food trader could now have at their disposal a wealth of new chemical knowledge that could easily be applied to the adulteration of food. In 1798, Fredrick Accum (1769-1838), a German chemist living in London, published a series of articles in *Nicholson's Journal* entitled "An Attempt to Discover the Genuineness and Purity of Foods and Medicinal Preparations". This was the prelude to Accum's historic treatise on food adulteration, published in 1820. The full title being (8):

A Treatise on Adulterations of Food and Culinary Poisons, Exhibiting the Fraudulent Sophistications of Bread, Beer, Wine, Spiritous Liquors, Tea, Coffee, Cream, Confectionery, Vinegar, Mustard, Pepper, Cheese, Olive Oil, Pickles, and Other Articles Employed in Domestic Economy, and Methods of Detecting Them

The cover leaf of the book depicted a skull in a cup bordered by snakes with the caption "There is Death in the Pot" (a phrase taken from II Kings, 2:40). A most informative biography of Accum can be found in a series of articles by Browne (9-11).

In this master work, Accum not only described in great detail the effects of eating foods contaminated with poisons (including numerous colored mineral salts) but also provided names and addresses of merchants selling these products. The following three examples from Accum's work will help to illustrate the extent of food adulteration in England during the first half of the 19th century (8):

A gentleman who had occasion to reside for some time in a city in the West of England was one night seized with a distressing but indescribable pain in the region of the abdomen and of the stomach accompanied with a feeling of tension, which occasioned much restlessness, anxiety, and repugnance to food ... in 24 hours the symptoms entirely vanished. He had recollected that he had ordered a plate of toasted Gloucester cheese of which he had partaken heartedly and which, at home, he had regularly ate for supper. The landlady (of the Inn) ordered the cheese to be examined by a chemist who reported that the cheese was contaminated with lead. It was found that the color of the cheese was heightened with red lead!

... Vegetable substances, preserved in a state called pickles, whose sale frequently depends greatly upon a fine lively green color, are sometimes intentionally colored by means of copper ... numerous fatal consequences are known to have ensued ... a young lady amused herself by eating pickles impregnated with copper. She soon complained of a pain in the stomach ... in nine days after eating the pickle,



Fredrick Accum (1769-1838)

death relieved her of her suffering.

... The mode of preparation of ... (anchovy) fish sauce consists of rubbing down the broken anchovy in a mortar; and this triturated mass, being of dark brown color, receives, without much risk of detection, a certain quantity of Venetian Red ... adulterated with orange lead ... for the purpose of coloring it.

Accum prophetically warned against the use of these colors and listed foods most commonly adulterated with these poisons. Confectionery products were often contaminated with one or more of the following: red sulfuret of mercury (mercury sulfide), verdigris (copper acetate), blue vitriol (copper sulfate) sugar of lead (lead acetate), white lead (lead carbonate), and Scheele's green (copper arsenite). Accum's work attracted some attention in the United States which, up until this time, appears to have had little interest in the problem of food adulteration. An American edition of Accum's book was published by A. Small of Philadelphia in 1820.

In 1831, an article by William B. O'Shaughnessy (1809-1889), entitled "Poisoned Confectionary", appeared in *The Lancet* (12). In this paper, the author discussed the composition of colored confectionery as well as the papers in which they were wrapped. Not surprisingly, the pigments found in the former included red oxide of lead, red sulfuret of mercury, and yellow chromate of lead. The wrapping paper, without exception, contained one or more of the following poisons: red sulfuret of mercury, yellow chromate of lead, or green carbonate of copper. O'Shaughnessy made the following plea (12):

It will scarcely be believed that the only enactments in the English code relating to public health ... are those which enforce the obser-



William B. O'Shaughnessy (1809-1889)



Arthur Hill Hassall (1817-1894)

vance of quarantine, (those) which prohibit the sophistication of wine, and the sale of unwholesome meat, or the meat bought of a Jew. In these particulars, it is that our continental brethren ... who have most outstripped us in their race with the progress of knowledge. The time, I trust, is not far distant when our legislature will perceive the necessity of imitating the rival nation in the establishment of councils of health.

In spite of this plea, and of the serious concerns previously raised by Accum, there was no discernible government action in England to regulate food adulteration at this time. In fact, Accum's enemies (of which he had many) forced him to return to his native Germany in 1821 under what appears to be unproven charges of mutilating library books! The result was that food adulteration in England continued unabated for another 30 years.

On the continent, particularly in France, Belgium and Switzerland, food manufacturers had long been forbidden to use injurious color additives under severe penalties. As early as 1800, French law forbade the use of any mineral pigments in candy. Under the orders of the Préfet de Police of Paris, 10 December 1830, it is stated (13):

It is forbidden to wrap sweetmeats in paper glazed or colored with mineral substances. It is ordered that all confectioners, grocers, and dealers in liqueurs, bonbons, sweetmeats, lozenges, etc., shall have their name, address, and trade printed on the paper in which the above articles will be enveloped. All manufacturers and dealers are personally responsible for the accidents, which shall be traced to the liqueurs, bonbons, and other sweetmeats manufactured or sold by them.

In the early 1850s, in England, Dr. Arthur Hill Hassall

(1817-1894), a physician, began a series of articles in *The Lancet* on food adulteration. These articles captured the imagination of the British public. In these papers and in his subsequent book (14) Hassall presented in great detail the extent of adulteration of foods, drugs and beverages.

The following bleak description of the plight of the British people at this time may help place the problem in perspective (15):

From morning to night he is the subject of perpetual fraud. He shaves himself with an inferior imitation of some high-priced soap; puts on a coat made of shoddy, and a hat of silk imitation of beaver. He drinks chicory and beans in his coffee, water in his milk, and organic matter of the vilest kinds, with the animalcules which are its scavengers, in the water itself. He may reasonably expect to be poisoned with his wines and liqueurs; but he is unsuspecting that he is eating lard in his butter, alum in his bread, disgusting parasites, flour and gypsum in his sugar, meal in his mustard, turmeric in his ginger, sulphuric acid in his vinegar, lead in his cayenne, copper in his pickles, gelatine in his isinglass, potato-starch in his arrowroot, and many mineral poisons in bonbons and confectionery, or that his potted meats may be made of horseflesh, his tea of used leaves revamped, his cigar falsified, and his cocoa adulterated with meal and flour.

Like Accum, Hassall not only listed the mineral salts utilized as colorants, but also provided names and addresses of those responsible for selling these poisons. Hassall describes a candy pigeon cake ornament as follows (16):

The pigments employed for colouring the pigeon are *light yellow* for the beak, *red* for the eyes, and *orange-yellow* for the base or stand. The yellow colour consists of the light kind of CHROMATE OF LEAD, or PALE CHROME; for the eyes, BISULFURET OF MERCURY, or VERMILLION, and for the stand, the deeper variety of CHROMATE OF LEAD, or ORANGE CHROME.

Of the 101 samples of confectionery products analyzed by Hassall, 50 were colored with chromate of lead, 12 with red oxide of lead, six with bisulfuret of mercury, one with carbonate of copper, and nine with arsenite of copper. In several cases, there were as many as three or four poisons in a single sample. The human toxicity of these colors was well known at the time which makes it all the more unbelievable that their use was so widespread. As Hassall states (16):

The preparations of lead, mercury, copper and arsenic, are, what are termed cumulative - that is, liable to accumulate in the system little by little, until at length it becomes thoroughly impregnated or saturated with these poisons.

Hassall makes a particularly strong point in stating his concern that tainted confectionery is consumed primarily by children (16):

Table 1. Foods commonly adulterated with mineral colorants in the mid 19th century.

<i>Food</i>	<i>Coloring Agent</i>
Colored confectionery	Arsenite or chloride of copper
Pickles, bottled fruit	Acetate or sulfate of copper
Custard powders	Chromate of lead
Cayenne & curry powder	Red oxide of lead
Chocolate	Sulfide or red oxide of mercury
Butter	Carbonate or acetate of lead
Tea	Chromate of lead

The deadly poisons, like the above, should be daily used for the mere sake of imparting colour to articles of such general consumption as sugar confectionery - articles consumed chiefly by children, who from their delicate organization are much more susceptible than adults - is both surprising and lamentable. It is surprising, on the one hand, that the manufacturers of these articles should be so reckless as to employ them; and, on the other hand, that the authorities should tolerate their use.

In addition to candy, tea, cayenne powder and pepper were also commonly colored with mineral pigments at this time. Tea was often contaminated with iron sulfate, lead chromate, copper carbonate, copper arsenite, prussian blue and indigo. Tea seized by the authorities in London contained 35% copper carbonate by weight. Another sample in Manchester, England was found to be dyed with potassium chromate.

Cayenne and curry powder were adulterated with red oxide of lead, red sulfuret of mercury, and/or copper acetate to conceal other adulterations and to maintain a bright red color (since both of these spices lighten in sunlight). Gooseberries, rhubarb and olives were often colored with copper sulfate which also acted as a preservative. Hassall emphasized the extent of the problem in England in the middle of the 19th century as follows (14):

I had bought a bottle of preserved gooseberries ... and had had its contents transferred into a pie. It struck me that the gooseberries looked fearfully green when cooked ... after having ... mashed the gooseberries with a steel fork, I was about to convey some to my mouth when I observed the prongs to be completely coated with a thin film of bright metallic copper.

Even wine did not escape the adulterer's hand. Hassall notes that wine not infrequently contained lead. The source of this was lead acetate which was added to prevent souring, increase sweetness, and render muddied white wines clear. Hassall notes that "there is scarcely a country in Europe, except England, in which the employment of the poisonous pigments

in this report is not prohibited under the severest penalties" (16).

Partly as a response to these strong statements, Parliament appointed a committee to investigate the extent of food adulteration. They concluded that indeed, public health was endangered by these additives and passed the Adulteration of Food and Drink Act of 1869. This empowered "public analysts" to test foods submitted by local health authorities and by British citizens. Little by little, toxic mineral pigments were removed from foods and beverages in England.

Meanwhile in the United States, there appears to have been little organized opposition to the adulteration of foods and beverages until the 1850s. In 1859, an article appeared in *Merchant Magazine* on "adulterations in Foods and Drugs" which discussed a report in a Boston newspaper (*The Boston Traveler*) on the doctoring of foods with questionable additives (17). Foods commonly adulterated with poisonous mineral salts in the United States at this time are listed in Table 1.

During the mid-1800s, in the United States, it was virtually impossible to find any food, drink, or medicine that had escaped extensive contamination. Even cod liver oil was adulterated almost to substitution with train oil mixed with iodine. Yellow-tinged milk was so common that people refused to purchase white milk thinking that the latter had been doctored. The yellow tint in milk (often produced by the addition of lead chromate) was present to prevent detection of skimmed or watered milk, which has a blue hue.

In 1862 the *North American Review* printed an article outlining Hassall's work that ended with the following plea (15):

In Massachusetts, we have very few restrictive laws on such subjects; and even these - as the laws relating to the weighing and stamping of bread, and sale of milk - are a dead letter and inoperative. When we see the difficulty of passing an effective law in England, as compared with the more positive and executive governments of the continent of Europe, we may form some idea as to the possibility of enacting prohibitory statutes against adulteration in this country, and of executing them afterward. There are few journals that have either the courage or the position and ability of the *Lancet* to expose these frauds; besides which, the result of such exposures can only be temporary. The best that can be done is to enlighten the public thoroughly and frequently as to what they are unconsciously suffering, through the press; and finally public opinion may take up the subject, and pass laws and enforce sufficient penalties. Until then, we fear that the defrauded consumer of adulterated foods can have as his only safeguard that insufficient maxim of jurisprudence, CAVEAT EMPTOR!

In 1856, the English chemist William Perkin (1838-1907) prepared the first synthetic dye, "aniline purple" or mauve, from coal tar. Within a few years, a variety of these organic dyes began to replace mineral pigments as food colorants. However, toxic inorganic salts continued to be used as food

colors up to the turn of the century as can be seen from the following (18-19):

* In Boston, MA in 1880, 46% of candy sampled contained one or more mineral pigments, primarily lead chromate

* Well into the turn of the century, vermicelli manufacturers routinely added lead chromate to their product to provide the correct "egg-yellow" color

* It was common to color pickles and canned vegetables with copper sulfate until about 1905.

These conditions led inevitably to enactment in the United States of Federal laws prohibiting the coloration of foods and beverages with toxic mineral salts. In 1906, the Pure Food and Drug Act was signed by President Theodore Roosevelt (20). In this law, provision was made to certify food dyes by the Secretary of Agriculture, but, importantly, this certification was voluntary. This law, however, provided the foundation for the Federal Food, Drug, and Cosmetic Act of 1938 which made certification mandatory for the 15 aniline based food colors then on the list. Our present six certified artificial food colors are all derived from coal tar, rather than from inorganic minerals. Present government requirements for the certification and safety of these six food colors are the same as for the certification of all food additives and include premarket safety evaluation. Although some concerns are presently expressed over the safety of food additives in general and food colors in particular, we have come a long way from the pre-regulation era when lead, copper, mercury and arsenic salts were routinely added to almost every food and beverage in the marketplace.

References and Notes

Acknowledgments: The author wishes to thank the Beckman Center for the History of Chemistry and Saint Joseph College for providing travel grants to the University of Pennsylvania Library's Edgar Fahs Smith Memorial Collection in Philadelphia. Parts of this paper were originally presented at the 200th National Meeting of the American Chemical Society, Washington, DC, 1990, Abstract HIST 010.

1. Pliny, *Natural History*, Vol. 4, Book XIV, H. Rackham ed., Harvard University Press, Cambridge, MA, 1945, pp. 232-233. For more background on the history of wine adulteration see R. P. Wedeen, *Poison in the Pot: The Legacy of Lead*, Southern Illinois University, Carbondale, IL, 1984.
2. A. W. Blyth, *Foods: Their Composition and Analysis*, C. Griffin & Co. Ltd., London, 1909, p. 30.
3. F. A. Filby, *A History of Food Adulteration and Analysis*, Allen & Unwin Ltd., London, 1934, p. 73.
4. F. L. Hart, "A History of the Adulteration of Food Before 1906", *Food, Drug, Cosmetic Law Journal*, 1972, 7, 11.
5. P. B. Hutt and P. B. Hutt II, "A History of Government Regulation and Misbranding of Foods", *Food, Drug, Cosmetic Law Journal*, 1984, 39, 19.
6. Anonymous, *Poison Detected*, 1757.

7. J. Manning, *The Nature of Bread Honestly and Dishonestly Made*, 1757.

8. F. C. Accum, *A Treatise on Adulteration of Foods and Culinary Poisons*, 4th ed., Longmans, Hurst, Rees, Orme, and Browne, London, 1822. 19th century use of inorganic pigments to color food is also discussed in W. A. Campbell, "Vermilion and Verdigris - Not Just Pretty Colours", *Chem. Brit.*, **1990**, 26, 558-560.

9. C. A. Browne, "The Life and Chemical Services of Fredrick Accum", *J. Chem. Educ.*, **1925**, 2, 827-851.

10. *Ibid*, pp. 1008-1034.

11. *Ibid*, pp. 1140-1149.

12. W. B. O'Shaughnessy, "Poisoned Confectionary", *Lancet*, **1830**, II, 1194-198.

13. Filby, p. 217.

14. A. H. Hassall, *Adulterations Detected: or Plain Instructions for the Discovery of Fraud in Food and Medicine*, Longman, Brown, Green, Longmans, and Roberts, London, 1857.

15. *North American Review*, Jan. 1862, No. CXCIV, p. 4.

16. A. H. Hassall, "Poisonous Coloured Confectionery", *Lancet*, **1854**, 581-584.

17. *Merchants' Magazine*, **1859**, 41, 654.

18. National Academy of Sciences, *Food Colors*, Washington, DC, **1971**, 2.

19. A. J. Wedderburn, *A Popular Treatise on the Extent and Character of Food Adulteration*, U. S. Department of Agriculture, Washington, DC, 1890.

20. The most recent history of the Food and Drug Act of 1906 is J. Young, *Pure Food: Securing the Federal Food and Drug Act of 1906*, Princeton University Press, Princeton, NJ, 1989. Even earlier American precursors are discussed in M. Okun, *Fair Play in the Marketplace: The First Battle for Pure Food and Drugs*, Northern Illinois University, DeKalb, IL, 1986.

Harold T. McKone is Professor of Chemistry at Saint Joseph College, West Hartford, CT 06117 and is particularly interested in the history, chemistry and biochemistry of food additives.

EARLY INDUSTRIAL pH MEASUREMENT AND CONTROL

John T. Stock, University of Connecticut

Being used for sales pitches for cosmetics and the like, the term "pH" has become part of our everyday language. The importance of pH ("hydrogen ion concentration" in the older literature), and hence of its measurement and control, is therefore readily accepted.

Nowadays, the glass-electrode pH meter is a very common instrument. Although the glass electrode was described in

1909 (1), its high electrical resistance delayed its routine use until the development of suitable electronics nearly three decades later. Accordingly, pH measurements were made in the laboratory by the use of chemical indicators, or by low-resistance potentiometric indicators such as the hydrogen, antimony-antimony oxide, or quinhydrone electrodes (2).

Adaptions of these systems filled some important industrial needs until glass-electrode technology reached a state of maturity. For example, a rather complicated system for the control of water-softening by the lime-soda process was patented in 1906 (3). Dosing was regulated by photometrically monitoring the color change of phenolphthalein. Concerning potentiometric systems, the hydrogen electrode has a long and interesting history (4). One of its earliest industrial applications was to the estimation of the acidity of tanning liquors (5).

Earl A. Keeler was greatly involved in the development and use of the industrial hydrogen electrode. He was born in 1892, joined Leeds & Northrup in 1913, and remained with this instrument-making firm until the end of 1922. Judging by the gentle fun poked at him by the editor of the firm's house journal *The Recorder*, Keeler was a popular staff member. Apart from his activities in connection with pH, he was a leading figure in the industrial applications of electrolytic conductance. Keeler later joined the Brown Instrument Company, but was then concerned mainly with humidity measurement, furnace-gas

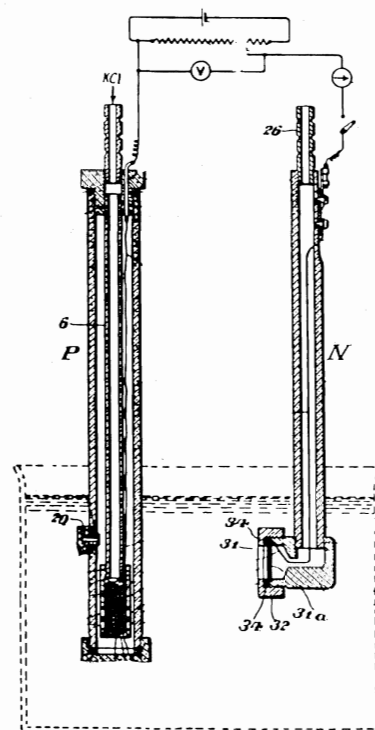

Figure 1. Keeler's 1923 design for a "robust" Bakelite-embedded hydrogen-calomel electrode system for use in industrial pH determinations (7).

Figure 2. An alternative electrode design from Keeler's 1923 patent with both the cathode and anode embedded in a single Bakelite rod (7).

analysis, and temperature control.

Keeler's patent, applied for in 1920, described circuitry to modify the signal from a hydrogen-calomel electrode combination so that a voltmeter could be made to read directly in pH units. This patent was not granted until 1926 (6). By then he had filed, and had been granted, another patent concerned with a robust industrial-type hydrogen-calomel electrode system (7). This is shown in Figures 1 and 2. Structurally, hydrogen electrode N and calomel electrode P were based on hard rubber, Bakelite, or the like. One of the problems with any kind of hydrogen electrode is that the platinized platinum element which forms the actual electrode is easily deactivated by sludge deposition or by "poisoning". In Keeler's design, a platinum gauze disk 31, retained by screwcap 32 and gasket 34, was used. The disk could be readily removed for cleaning, replatinization, or replacement. Hydrogen, supplied through tube 26, passed through the gauze and out into the solution. As with hydrogen electrodes for laboratory use, the flow of gas was so slow that there was no danger of a fire hazard.

A platinum gauze rectangle coated with mercury(I) chloride-mercury paste, rolled up, and placed in a silk bag, was the basis of the calomel electrode P. Decinormal potassium chloride solution flowed from a reservoir down through central tube 6, through the bag, then out into the test solution. The capillary orifice in plug 20 kept the flow rate very

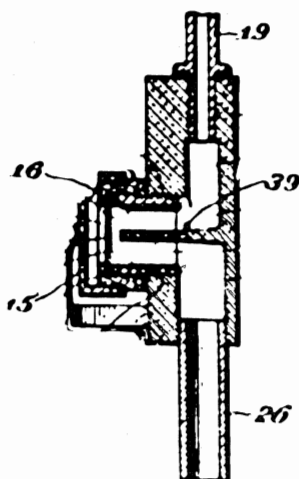
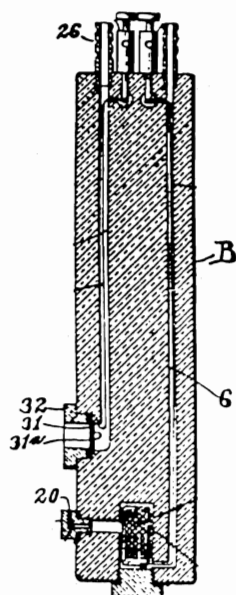

Figure 3. A detail from Keeler's 1923 patent for the monitoring of pH in flow systems (8).



low. An obvious extension, also shown, was to make a single unit that contained both indicator and reference electrodes.

Similar principles were used in a system for flowing streams. Figures 3 and 4, reproduced from the patent (8), show the arrangement. A feature was presaturation of the stream with hydrogen before reaching the indicator electrode. The stream, which might be raw water with a pressure head of about 10 feet, entered glass-wool filter 25 through tube 23. Emerging from jet 20, the stream entrained electrolytically-generated hydrogen entering through tube 22. Deflected horizontally, the stream passed through the platinum gauze disk, over the dam 16 formed in cap 15, into chamber 5, and then left by discharge pipe 26. The body of the system also contained the flow-type calomel electrode. A capillary opening 39 connected this with chamber 5.

Keeler stated that, in determining the acidity of water, air

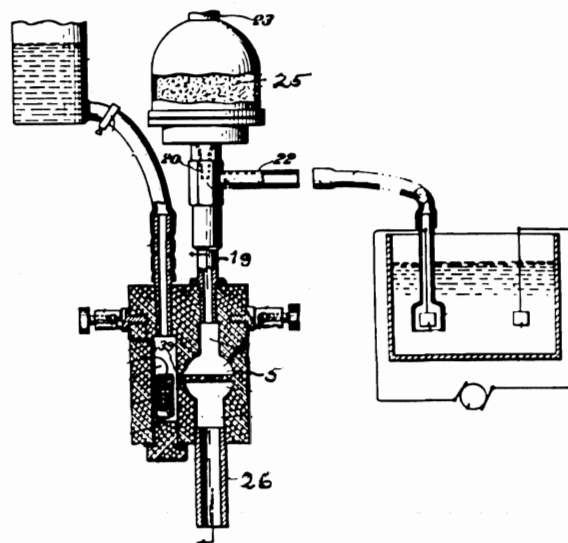

Figure 4. A detail from Keeler's 1923 patent for the monitoring of pH in flow systems (8).

proved satisfactory as the gas. Apparently, the action was then that of an oxygen electrode, so that the calibration of the system had to be suitably adjusted.

The next steps were the recording of pH and, if necessary, its control. In 1922, Irving B. Smith and Keeler filed a description of equipment for the performance of these steps. The patent, which included the diagram shown in Figure 5, was not issued until 1928 (9). The complicated appearance of the diagram is largely due to "known art", i.e., the mechanism of a chart recorder that was patented in 1915. An excellent description of the principles of this type of recorder is available (10).

A hydrogen-calomel electrode system developed a potential dependent upon the pH of the solution flowing into vessel A. This potential shifted the pointer of galvanometer G, which is part of the recorder mechanism, causing pen 40 to indicate

the pH on the motor-driven chart. The overflow tube, *m*, of vessel *C* kept constant the rate of flow into *A*, which had its own overflow tube.

Suppose that an acidic flowing stream has to be brought to a desired pH by the addition of sodium hydroxide solution, delivered at constant head from vessel *D* through valve *V*. The degree of opening of this valve, controlled by wheel *W*, a part of the recorder mechanism, suitably adjusted the flow of alkali to produce the desired pH. This was selected by appropriately setting wiper, *i*, of potentiometer *R*. If pH adjustment was possible by mere dilution, then sodium hydroxide solution was replaced by water.

The inevitable delay after filing patent specifications did not hinder Keeler from publicizing some of the industrial applications of his inventions. He pointed out that potentiometric alkalinity control in the carbonation of sugar juices was not affected by color differences (11). Electrode systems similar to those shown in Figure 1 were illustrated in two articles on potentiometric control of industrial processes. The first referred to the processing of beet and pineapple juices, water purification, wool scouring, leather tanning, and sewage disposal (12). Boiler feed control was the main concern of the second article (13). This topic was treated more extensively in an article co-authored by a power station engineer (14).

It is well known that the quinhydrone electrode is not precise if the pH is greater than about 8 (2). An additional objection from the industrial point of view is that quinhydrone must be added to the sample. In 1931, Charles C. Coons examined two methods for dosing flowing sample streams (15). One involved passage of the stream through solid quinhydrone, either retained in a cloth sack or in pellet form. He concluded that the other method, addition of quinhydrone

solution to the stream, was simpler and more effective.

To test the efficiency of the "solution" method, runs that lasted several days were made with continuously-flowing tap water. At intervals, the flow was switched to one of slightly acidified water and then back to the original stream. Uniform response to these switchings was obtained. Also writing in 1931, George A. Perley referred to the use of the quinhydrone solution-feed technique in waterworks practice (10).

The literature concerning the antimony-antimony oxide electrode is extensive (16). In 1939, Perley examined the industrial possibilities of this electrode, where a limit of error of 0.1 to 0.2 pH was acceptable (17). The recommended form of electrode, merely a stick cast from high-purity antimony, was very robust. The addition of antimony oxide was not necessary, because this sparingly soluble compound forms on the surface when antimony comes in contact with air-containing aqueous solutions. A rubber-coated stick, the exposed end of which is ground and polished, was found to be superior to other forms. In the same 1939 article, Perley stated that over 500 industrial pH installations were using the molded rubber-coated antimony electrode (17). Satisfactory performance was obtained in a wide variety of applications, such as in

beer, alum solutions, paper-mill liquors, water treatment systems, clay suspensions, and the like (18).

When used in conjunction with a low-resistance reference electrode, the pH electrodes discussed could supply the small current needed to operate the galvanometer-type recorders then in use. With the discovery and development of the triode and later vacuum tubes, the need for these low-resistance electrode systems began to disappear. pH meters and recorders having a high input impedance could be made, so that the electrical resistance of the electrode system no longer re-

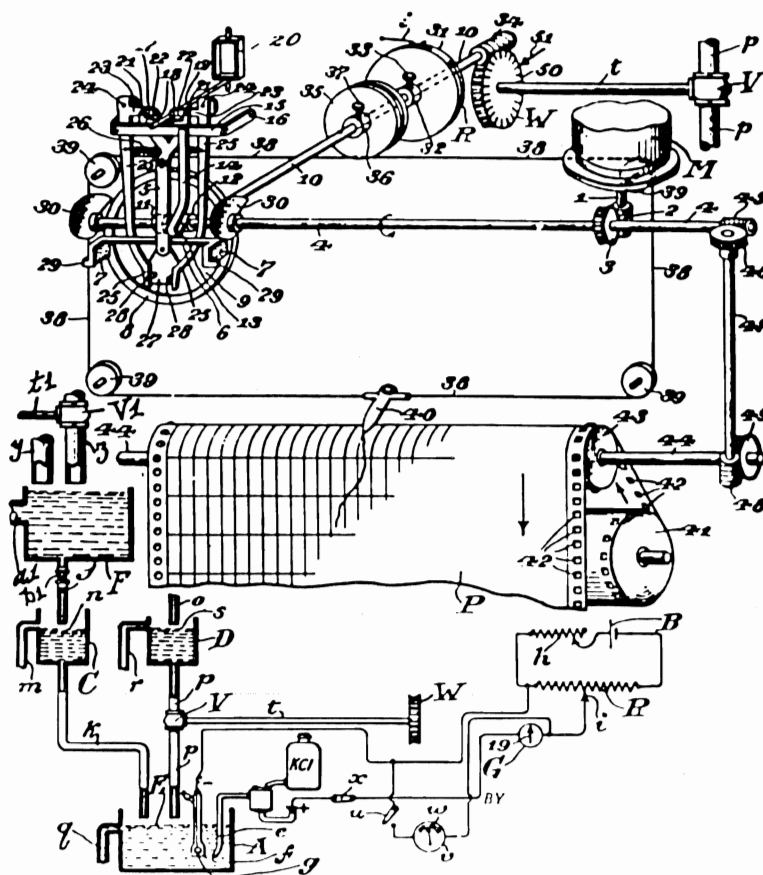

Figure 5. Keeler and Smith's 1928 design for the automatic recording and control of pH in industrial processes (9).

When used in conjunction with a low-resistance reference electrode, the pH electrodes discussed could supply the small current needed to operate the galvanometer-type recorders then in use. With the discovery and development of the triode and later vacuum tubes, the need for these low-resistance electrode systems began to disappear. pH meters and recorders having a high input impedance could be made, so that the electrical resistance of the electrode system no longer re-

mained an important consideration. The flow-type calomel electrode could be replaced by one designed to give an almost negligible flow of potassium chloride solution. One of the most successful designs, described in 1947, made use of a controlled-crack junction tube (19). Pyrex glass was used for the body of the tube. A hole 5 to 10 mm in diameter was blown in the bottom and the hole was closed by sealing in a plug of glass having a high coefficient of expansion. After proper annealing, a permanent crack of controlled dimensions was obtained. A typical leak rate was 0.006 mL/hr.

Because of improvements in instrumentation, the high resistance of the glass electrode ceased to be a handicap, and it became the pH electrode of choice. Once this had occurred, highly-specialized glasses that provided a stable, much improved performance were discovered and exploited (20-22).

References and Notes

Acknowledgment: This work was partially carried out under the Research Fellowship Program of the Science Museum, London. I am most grateful to Joseph A. McGuriman, of the Human Resources Department of Leeds & Northrup, for background information on Earl Keeler.

1. F. Haber and Z. Klemensiewicz, "Über elektrische Phasengrenzkräfte", *Z. Phys. Chem.*, **1909**, *67*, 385-431.
2. J. T. Stock, "Einar Biilman (1873-1946): pH Determination Made Easy", *J. Chem. Educ.*, **1989**, *66*, 910-912.
3. J. T. Stock, "Lime, Soda and Selenium", *Trends Anal. Chem.*, **1983**, *2*, 261-262.
4. A. M. Von Smolinski, C. E. Moore, and B. Jaselskis, "The Choice of the Hydrogen Electrode as the Base for the Electromotive Series", in J. T. Stock, and M. V. Orna, eds., *Electrochemistry, Past and Present*, American Chemical Society, Washington, DC, 1989, pp. 127-141.
5. J. T. Wood, H. J. S. Sand, and D. J. Law, "Electrometric Method for the Estimation of the Acidity of Tan Liquors", *J. Soc. Chem. Ind. (London)*, **1911**, *30*, 872-877.
6. E. A. Keeler, "Ionic-Concentration Meter", U. S. Patent 1,604,584, **1926**.
7. E. A. Keeler, "Electrode for Ion Concentration Effects", U. S. Patent 1,474,151, **1923**.
8. E. A. Keeler, "Method of and Apparatus for Obtaining Ion Concentration Effects", U. S. Patent 1,474,594, **1923**.
9. I. B. Smith, and E. A. Keeler, "Ion Concentration Control", U. S. Patent 1,684,645, **1928**.
10. G. A. Perley, "Control Methods in the Chemical Industry", *Chem. & Ind. (London)*, **1931**, *50*, 452-460.
11. E. A. Keeler, "Control of Alkalinity", *Facts About Sugar*, **1921**, *12*, 490; as cited in *Chem. Abstr.*, **1921**, *15*, 2746.
12. E. A. Keeler, "The Application of Ion-Concentration Measurements to the Control of Industrial Processes", *Ind. Eng. Chem.*, **1922**, *14*, 395-398.
13. E. A. Keeler, "Hydrogen Ion and Other Electrical Measure-

ments as Applied to Process Control", *Ind. Eng. Chem.*, **1922**, *14*, 1010-1012.

14. R. C. Arthur, and E. A. Keeler, "A Meter for Recording the Alkalinity of Boiler-Feed Water", *Power*, **1922**, *55*, 768-770.
15. C. C. Coons, "Continuous Measurement of pH with Quinhydrone Electrodes", *Ind. Eng. Chem., Anal. Ed.*, **1931**, *3*, 402-407.
16. J. T. Stock, W. C. Purdy, and L. M. Garcia, "The Antimony-Antimony Oxide Electrode", *Chem. Rev.*, **1958**, *58*, 611-626.
17. G. A. Perley, "Antimony Electrode for Industrial Hydrogen-Ion Measurements", *Ind. Eng. Chem., Anal. Ed.*, **1939**, *11*, 316-318.
18. G. A. Perley, "Characteristics of the Antimony Electrode", *Ind. Eng. Chem., Anal. Ed.*, **1939**, *11*, 319-322.
19. G. A. Perley, "An Industrial Salt-Bridge Junction Tube", *Trans. Am. Electrochem. Soc.*, **1947**, *92*, 497-506.
20. G. A. Perley, "Composition of pH-Responsive Glasses", *Anal. Chem.*, **1949**, *21*, 391-394.
21. G. A. Perley, "pH Response of Glass Electrodes", *Anal. Chem.*, **1949**, *21*, 559-562.
22. G. A. Perley, "pH-Responsive Glass Electrode", U. S. Patent 2,444,845, **1948**.

John T. Stock is Professor Emeritus in the Department of Chemistry of the University of Connecticut, Storrs, CT 06269, and is especially interested in the history of chemical instrumentation and electrochemistry.

OLD CHEMISTRIES

James Tytler's "A System of Chemistry"

William D. Williams, Harding University

In the year 1791, the United States was slowly becoming a nation. George Washington was in the third year of his presidency. Vermont became the 14th state. The Bill of Rights amendments to the Constitution went into effect. And Philadelphia publisher Thomas Dobson marketed *A System of Chemistry* (1). This volume was the second full-size chemistry book published in America (2) and the first American imprint to introduce the new chemistry of Lavoisier and his French colleagues (3).

A year earlier, Dobson had begun the ambitious task of publishing an American edition of the 18-volume *Encyclopaedia Britannica*. He was pirating the third Edinburgh edition of *Britannica*, which was issued in 300 parts from 1788 to 1797. As each part reached America, Dobson would have a few of the articles edited by Americans and issue half-volume sections every ten weeks. The American title, *Encyclopaedia; or Dictionary of Arts, Sciences and Miscellaneous Literature*, merely omitted the word "Britannica" from that of the Edinburgh edition. Title pages bear the date 1798 because front

pages were not printed until all 36 half-volumes were finished.

During 1791 Dobson was working on volume IV, which contained a 238-page article on chemistry (4). Using the same type prepared for the *Encyclopaedia*, he also published it as a separate monograph under the title, *A System of Chemistry*. Nicely bound in full calf, the volume used superior quality paper manufactured in Pennsylvania and special type was cast for the work by Baine and Company of Philadelphia (5). With small print on 8 x 10 inch pages, it was the equivalent of 400 to 500 pages of typical size and type. It was an impressive, comprehensive treatise on chemistry, the first such published in America. Dobson would later pirate another treatise on chemistry from the *Britannica Supplement* of 1800. Table 1 summarizes the relationship of early chemistry to the *Encyclopaedia Britannica* (6).

Lavoisier's new nomenclature was mentioned in an appendix, which contained "discoveries as have appeared since the compilation of the article". It gave quotations from Lavoisier's explanation of the new system and inserted a folded chart contrasting the new names with the ancient names. This chart had been copied into the Edinburgh edition from the 1790 London edition of Fourcroy's *Elements of Natural History and Chemistry* (7). A personal comment from the *Britannica* author indicated that he was not yet converted to the new system: "Whatever may be the defects of the old one [nomenclature], we are ready to be involved in much greater difficulties by the introduction of a new one." Although admitting that the new system "has attracted no small degree of attention", he worried that future innovations would result in "endless vocabulary" (8).

Although no author is listed in *System of Chemistry*, it was written by James Tytler (1747-1805). An eccentric character, Tytler was at various times a chemist, physician, printer and publisher, literary hack, balloon aeronaut and political gadfly. He was commonly called "Balloon Tytler" from being the first person in Great Britain to fly in a hot air balloon. The poet Robert Burns described Tytler as (9):

... an obscure, tippling, though extraordinary body of the name of Tytler, commonly known under the name of Balloon Tytler, from his having projected a balloon; a mortal who, though he drudges about Edinburgh as a common printer, with leaky shoes, a sky-lighted hat, and knee-buckles as unlike as George-by-the-grace-of-God and Solomon-the-son-of-David, yet that same unknown mortal is author and compiler of three-fourths of Elliot's pompous *Encyclopaedia Britannica*, which he composed at half a guinea a week.

The preface to the Edinburgh third edition of *Britannica* stated (10):

Aerology, aerostation, chemistry, electricity, gunnery, hydrostatics, mechanics, meteorology with most separate articles in the various branches of natural history, we have reason to believe were compiled



James Tytler (22)

by Mr. James Tytler, chemist, a man who though his conduct has been marked by imprudence, possesses no common share of science and genius.

The uncertainty of the editor George Glaig's statement is due to his being hired in 1793, after the work was well in progress. By that time, the original editor, Macfarquhar, had died and Tytler had left the country.

The preface of the *Britannica* also contained a cryptic acknowledgment to Joseph Black (11):

There is, however, no man to whom the proprietors of the *Encyclopaedia Britannica* feel themselves under greater obligation than to Dr. Black for the very handsome offer he made to the person who was at first entrusted with the chemical department of the work.

Joseph Black (1728-1799), professor of chemistry at the University of Edinburgh from 1766 to 1796, was the foremost British chemist of the time. It is not known what contribution Black made to Tytler's chemistry treatise. Perhaps he reviewed Tytler's work or perhaps he allowed Tytler to use his library. Although Black's *Lectures on Chemistry*, edited by John Robison, were not published until 1803, many student manuscript copies were in circulation at the time Tytler wrote his article. A comparison of Tytler's work with Black's *Lectures*, however, reveals no particular similarity. Tytler does not refer to Black any differently than other authorities. Indeed, Tytler mentions Crawford's work on heat more than that of Black.

One is impressed with the thoroughness of Tytler's *System of Chemistry*. It was a masterful composite of the state of chemistry in 1791. It reads as though Tytler had made an exhaustive search of the existing literature. He used current research from the *Philosophical Transactions* and the *Chemical Annals*, as well as from various "Berlin Memoirs", and "French Memoirs." Almost every paragraph named a scientist and gave a concise summary of his concept, experiment or contribution. Specific references were rarely given, but literally hundreds of authorities from many countries were identified with such phrases as "Mr. ___ has observed", "According to Mr. ___", "Dr. ___ is of the opinion", etc.

Few quotations were present; Tytler preferred to summarize the work of others. He was remarkably adept at extracting the essence of a large, complicated topic. He would often give the explanations of more than one person for the same concept. Although phlogistonist views were used, he recognized that Lavoisier had performed conflicting experiments.

Tytler does not appear to have used any single work as a basis for his treatise. The only sources he mentioned by name were: "The Chemical Dictionary" (probably Macquer's anonymous *Dictionnaire de Chymie*), Scheele's *Chemical Essays*, Lewis' *Commercium Philosophico-Technicum or Philosophical Commerce of the Arts*, "Kirwan's treatise on phlogiston", "Crawford's treatise on heat", "Shaw's edition of Boerhaave", and Wiegler's *System of Chemistry*.

The book contained five sections: History (pages 5-8), Theory (pages 9-89), Practice (pages 89-230), Tables (pages 230a-246), and Index (pages 247-269). The contents were well outlined with headings and paragraph topics were given in margin notes. Three plates depicted chemical symbols, furnaces and glass laboratory vessels. In addition to the table of new nomenclature described above, there was a 15-page table of the classification of chemical substances. This table was an updated version of one that appeared in the 1771 first edition of *Encyclopaedia Britannica*. The extremely detailed index even included a few paragraphs of text that apparently were last-minute additions. Except for the page numbers, all contents were identical to the *Encyclopaedia* article on chemistry.

On three occasions Tytler inserted a personal viewpoint. One of these is quoted above in the discussion of Lavoisier's new nomenclature, but perhaps the others will give an insight into his personality (12). Thus on page 81:

It seems surprising that this able chemist, who on other occasions had the improvement of the arts so much at heart, did not put some vessels of this kind of porcelain to other severe trials ... When a first rate chemist publishes any thing in an imperfect state, inferior ones are discouraged from attempting to finish what he has begun ...

and again on page 100:

We cannot here help again regretting that chemists of superior

Table 1. Early Chemistry in the *Encyclopaedia Britannica* (6)

1st Edinburgh (3 v., 1771): Edited by William Smellie, who established the policy of comprehensive treatises on major subjects. The 114-page article on chemistry was essentially a copy of P. M. Macquer's *Elements of the Theory and Practice of Chemistry* (3rd, Edinburgh, 1768). A facsimile edition of the 1771 *Britannica* was published in 1968 (20).

2nd Edinburgh (10 v., 1777-1784): Edited and largely written by James Tytler. The 92-page article on chemistry was written by Tytler.

3rd Edinburgh (18 v., 1788-1797): Edited by George Glaig. James Tytler contributed some major science articles, including the 269-page article on chemistry.

1st Philadelphia (18 v., 1790-1798): Edited by Thomas Dobson. A partly rewritten copy of the 3rd Edinburgh. Published every ten weeks in 36 half-volume parts bound in boards. Complete 18 volume sets dated 1798 were bound in calf. The article on chemistry (v. IV, pp. 376-637) was a reprint of the Edinburgh original. This was also separately issued as *A System of Chemistry...* (pp. 269 plus folded chart, Philadelphia, 1791).

Supplement to 3rd Edinburgh (2 v., 1800-1801): Thomas Thomson wrote the chemistry treatise, introducing chemical symbols for the first time. This article became the basis of Thomson's *System of Chemistry* (4 v., Edinburgh, 1802). The first volume was anonymously reprinted as *A New System of Chemistry Comprising the Latest Discoveries and Improvements of the Science* (364 pp., Philadelphia, 1800). Although not on the title page, this volume also contained articles on mineralogy, animal and vegetable substances and dyeing substances. The chemistry article (pp. 1-198) was edited with footnotes by American scientist, Thomas P. Smith (21). A second reprinting appeared as *A New System of Chemistry including Mineralogy and Vegetable, Animal and Dyeing Substances ...* by Thomas Thomson (364 pp., Philadelphia, 1803): Except for title page, this was identical to the previous item (21).

Supplement to 3rd Philadelphia (3 v., 1803): The article on chemistry (v. I, pp. 257-453) was the same as that in the two previous items.

Supplement to 5th Edinburgh (6 v., 1816-1824): William Brande wrote one of the three keynote articles, "Dissertation Third: Exhibiting a General View of the Progress of Chemical Philosophy from the Early Ages to the end of the Eighteenth Century." This material became the preface to Brande's *Manual of Chemistry* (London, 1819), but was not included in the 1821 American edition edited by William J. Macneven. It was also reprinted as *Dissertation Third: Exhibiting a General View of the Progress of Chemical Philosophy from the Early Ages to the End of the Eighteenth Century*, By William Thomas Brande (120 pp., Boston, Wells and Lilly, 1818).

abilities should sometimes leave very important discoveries only half finished, so that chemists of inferior rank know not what to make of them.

James Tytler was born in 1745 in rural Scotland, where his father was a minister in the parish of Fearn (13). At an early age he was apprenticed to a local surgeon. About 1764 he enrolled in medical classes at the University of Edinburgh, where he studied chemistry under William Cullen.

During the following summer, Tytler served as a surgeon aboard the whaling ship *Royal Bounty* in the Greenland seas. Two months after his return to Edinburgh, at age 20, he was married to Elizabeth Rattray. This early marriage undoubtedly damaged a promising career. He did not return to medical classes and began a permanent struggle against poverty. Recognizing that he was inadequately prepared to practice medicine, he opened an apothecary shop. In 1766 this business failed and he fled to Northern England to escape debtors prison. He continued to make a precarious living as a chemist, preparing medicines for established apothecaries.

Returning to Edinburgh in 1772, he gradually turned to writing as a means of support. He began publishing a weekly magazine, but it failed after several months. He constructed his own printing press and published several religious works. Establishing a reputation as a "booksellers hack," he supplied translations, compilations and ghost articles for many publishers. He was uncommonly adept at abridging large works, which he often composed directly into type without writing a manuscript. His versatility, however, was not matched by business success. He was paid trifling sums. He drank heavily, lived in poverty, and provided miserably for his wife and five children. About 1775, his wife deserted him and took the children to live with her family. A second wife died in childbirth in 1782 and a third wife survived him, but poverty was their constant lot.

In 1775 debts caused Tytler to again flee prosecution. This time he took refuge, under the right of sanctuary, in the Abbey of Holyrood, registering as "James Tytler, chymist in Leith" (14). By 1776 he was back in Edinburgh and accepted the offer of Bell and Macfarquhar to edit the second edition of the *Encyclopaedia Britannica* for 17 shillings a week.

Tytler labored on the *Britannica* from 1776 to 1784. It was published in 101 parts and then bound as ten volumes. Some of the articles were carried over from the first edition (published in three volumes in 1771), but Tytler wrote an astonishing three fourths of the 9000 pages, including the 92-page article on chemistry. In spite of this demanding task, he pursued other literary enterprises. Another weekly magazine lasted about six months. He began an abridgement of a 20-volume history of the world, composing at the type case with the open volumes before him. Only one volume of this abridgement, *The General History of All Nations, Ancient and Modern*, covering from antiquity down to Alexander the Great,

A
S Y S T E M
OF
C H E M I S T R Y:
COMPREHENDING THE
HISTORY, THEORY, AND PRACTICE
OF THE
S C I E N C E,

ACCORDING TO THE LATEST DISCOVERIES AND IMPROVEMENTS.

ILLUSTRATED WITH COPPERPLATES.

EXTRACTED FROM THE AMERICAN EDITION OF THE ENCYCLOPEDIA,
NOW PUBLISHING,

By T. DOBSON, at the *Stone- Houfe*, in SECOND-STREET, PHILADELPHIA.

MDCCLXCI.

was published. He also published two English poetry translations of Virgil's works.

While writing articles on "Flying" and "Air Balloons" for the *Encyclopaedia*, Tytler became fascinated with the possibility of manned flight. The Montgolfier brothers had successfully ascended in a hot air balloon in France only the previous year. On 19 June 1784, the following advertisement appeared in the *Edinburgh Evening Courant* (15):

On Monday next, the 21st current, will be exhibited at Comely Garden by James Tytler, chemist, a fire balloon, of 13 feet in circumference, as a model of the Grand Edinburgh Fire Balloon, with which he intends to attempt the navigation of the atmosphere. As this exhibition is intended to give the public a demonstration of the principles upon which the Great Balloon will ascend ...

In an effort to gain subscriptions to finance his work, Tytler displayed the finished "Grand Edinburgh Fire Balloon" on 17 July 1784. It was 40 feet high and 30 feet in diameter, with a basket hung below that carried the aeronaut and a stove. Because the stove weighed so much, Tytler removed it when

the balloon was ready to ascend. After several failures and postponements, on 27 August 1784 Tytler became the first person in Great Britain to "navigate the air." Although the flight was only about half a mile and reached only 350 feet, Tytler was hailed as a courageous pioneer. He designed a larger stove and made other unsuccessful attempts. In a final trial, this time keeping the stove aboard, the balloon hit a tree and the stove exploded. The balloon was heavily damaged and Tytler barely escaped injury. Public excitement waned and balloon trials ceased, but Tytler continued to be known as "Balloon Tytler." Unable to profit from admissions to his balloon experiments, Tytler again found himself unable to meet his debts. For a second time he sought refuge in the debtors sanctuary at Holyrood, this time registering as "James Tytler, chemist and baloon [sic] maker in Edinburgh" (16).

By 1786, Tytler was back in Edinburgh working on the third edition of the *Encyclopaedia Britannica*. He was not editor of this edition, but contributed some scientific articles, including the 269-page treatise on chemistry. Interestingly, his articles on aerology and aerostation did not include any mention of his own efforts at balloon flight.

At the same time he was working on the *Britannica*, Tytler wrote comprehensive books on geography, travels and the history of Edinburgh. He published several songs and verses that came to the attention of the noted Scottish poet, Robert Burns. Burns' description of Tytler is quoted above. When Tytler wrote a pamphlet in defense of Mary, Queen of Scots, Burns sent his picture and "A poetical address to Mr. James Tytler," one stanza of which read (17):

I send you a trifle, a head of a bard,
A trifle scarcely worthy your care;
But accept it, good sir, as a mark of regard,
Sincere as a saint's dying prayer.

In 1788 Tytler's first wife, who had never been legally divorced, sued for divorce and damages. A summons was issued for "James Tytler, sometimes druggist in Leath, now chymist at or near Edinburgh" (18). Typically destitute, Tytler once again fled prosecution. The divorce was finally decreed while Tytler remained outside Scotland.

Upon his return to Edinburgh about 1791, Tytler became involved with a group advocating political reform. After he published several critical works, a warrant was issued for his arrest and he fled to Ireland. When he failed to appear before the court in 1793, he was banished from his native land. In 1795 he and his third family sailed for the United States.

Settling in Salem, Massachusetts, Tytler supported himself, as previously, by preparing medicines for druggists and by writing. He compiled an exhaustive *Treatise on the Plague and Yellow Fever* (1799). In 1801 he was hired by a Salem bookseller, at 121/2¢ an hour, to compile a "Universal Geog-raphy". He had nearly finished that task when, on the stormy

night of 8 January 1805, he fell into flood waters and drowned.

Although writing may have been his means of livelihood, Tytler appeared to consider himself a chemist. No less than six extant official documents list his occupation in Scotland as chemist. In the 1780s he helped construct a manufactory for magnesia, but was dismissed as soon as he got it into production. He developed a bleach for linen which was stolen by clothing merchants. He often procrastinated his writing to carry out experiments, one of which was an effort to construct a perpetual motion machine. A surviving diary of a friend in America described him as "a well known chemist, forced to leave his native country on account of his political views" (19). After his death, his wife knew enough about his practice to advertise that she could prepare ether and other medicines for the medical profession.

It is impossible to tell what influence Tytler's *System of Chemistry* had on American science. It was not referenced in any of the American chemistry imprints from 1792 to 1800, when another *Britannica* article on chemistry was published. European works were available, but, as the only American systematic survey of chemistry, *System* must have been used by serious chemists. One wonders if Tytler ever saw a copy of this book. It was a remarkable contribution to his adopted country.

References and Notes

1. *A System of Chemistry: Comprehending the History, Theory, and Practice of the Science, According to the Latest Discoveries and Improvements. Extracted from the American Edition of the Encyclopaedia, Now Publishing*, T. Dobson, Philadelphia, 1791.
2. The first full-size American chemistry book was reviewed in W. Williams and W. Miles, "John Penington's Chemical and Economic Essays", *Bull. Hist. Chem.*, **1990**, 8, 18-22.
3. This and several later American imprints about the new nomenclature are described in D. Duveen and H. Klickstein, "The Introduction of Lavoisier's Chemical Nomenclature into America," *Isis*, **1954**, 45, 278-292 and 368-382.
4. *Encyclopaedia; or a Dictionary of Arts, Sciences and Miscellaneous Literature ...*, T. Dobson, Philadelphia, 1798, v. 4, pp. 374-637.
5. C. Evans, *American Bibliography*, Vol. 8, Peter Smith, New York, 1941, p. 28.
6. H. Kogan, *The Great E. B. The Story of the Encyclopaedia Britannica*, University of Chicago Press, Chicago, 1958, pp. 3-30; *Encyclopaedia Britannica*, 9th ed., Vol. 8, R. S. Peale Co., Chicago, 1893, pp. 200-201.
7. A. Fourcroy, *Elements of Natural History and Chemistry*, C. Elliot and T. Kay, London, 1790 (three volumes), folding chart at the end of volume three. This was a translation of Fourcroy's *Éléments d'histoire naturelle et de chimie*, 3rd ed., Cuchet, Paris, 1789 (five volumes).
8. Reference 1, p. 230.

9. Quoted in Kogan, reference 6, p. 21. Burns was referring to the second edition of *Britannica*. Elliot was a local bookseller.

10. Reference 4, v. 1, p. xiii.

11. *Ibid.*, p. xiv.

12. Reference 1, pp. 81 and 100.

13. The most complete biography of Tytler is J. Fergusson, *Balloon Tytler*, Faber and Faber, London, 1972. Others are found in: H. Kogan, Reference 5, pp. 16-22; *Dictionary of National Biography*, Vol. 19, Oxford University Press, London, 1922, p. 1379; *Appleton's Cyclopaedia of American Biography*, Appleton, Vol. 6, New York, 1889, p. 204.

14. Quoted in Fergusson, reference 13, p. 44.

15. *Ibid.*, p. 63.

16. *Ibid.*, p. 85.

17. Quoted in Kogan, reference 6, p. 21.

18. Quoted in Fergusson, reference 13, p. 108.

19. *Ibid.*, p. 137.

20. *Encyclopaedia Britannica*, Bell and Macfarquhar, Edinburgh, 1769-71. Facsimile Edition, Encyclopaedia Britannica, Inc., Chicago, 1968. The chemistry article is reviewed in R. Gable, "Encyclopaedia Britannica: A Neglected Phlogistonist Textbook", *J. Chem. Educ.*, 1979, 56, 375-376.

21. W. Williams, "Mystery Editors of Early American Chemistry Texts", *Bull. Hist. Chem.*, 1988, 2, 6-7.

22. The engraving of Tytler is taken, with permission, from Kogan, reference 6, unpaginated illustrations at center of book. Another likeness is found in Fergusson, reference 13, p. 145.

William D. Williams is Professor of Chemistry at Harding University, Searcy, AR 72143. He collects and studies early American chemistry texts.

BOOK NOTES

From Caveman to Chemist, Hugh W. Salzberg, American Chemical Society, Washington, D.C., 1991. xix + 294 pp. (Typeset). \$14.95 (Paper), \$24.95 (Cloth).

There has never been a shortage of books dealing with the history of chemistry. In a 1974 bibliographic study, Jost Weyer listed no less than 71 general histories of chemistry written between 1561 and 1970 - a number which excludes specialized histories of subdisciplines, such as organic and analytical chemistry, and the equally voluminous literature dealing with the history of alchemy. Of these histories, 29, or roughly a third, are written in English or have appeared as English translations.

Upon examining the current edition of *Books in Print*, the chemist looking for a suitable text to use in a history of chemistry course, or just for personal study, will find that a surprisingly large number of these titles are still in print.

Excluding, for obvious reasons, modern reproductions of the classics by Thomas Thomson, Adolphe Wurtz, Ernst von Meyer, and M. M. Pattison Muir (originally published in 1830, 1868, 1889, and 1907, respectively), this list includes 20th-century works by James Partington, Henry Leicester, Aaron Ihde, Isaac Asimov, and Cecil Schneer.

Of these, Ihde's 1964 volume, *The Development of Modern Chemistry*, is by far the most detailed. Now available in an inexpensive Dover paperback reprint, its 851 pages cover the period from the 18th century to around 1950. It also has the best selection of portraits and illustrations ever to appear in a general history of chemistry. Though its size and detail make it difficult to effectively use in a one-quarter course, it is the best single-volume reference still in print and belongs on the shelves of every serious collector of chemical literature.

A more manageable overview is the Dover reprint of Leicester's 1956 volume, *The Historical Background of Chemistry*. Unlike Ihde's more detailed work, it gives equal treatment to alchemy and pre-18th century chemistry, though at the expense of terminating its treatment of modern chemistry around 1920. At 260 pages, it is less than a third the length of Ihde's work, but purchases its brevity with a lack of detail and the absence of the fine selection of illustrations found in Ihde.

The most recent addition to Dover's list of quality paperbacks is their reproduction of Partington's classic 1937 volume, *A Short History of Chemistry*. Despite the fact that it is 20 years older than Leicester's work, it is quite similar in both its length (386 pages) and period of coverage (prehistory - 1920).

Asimov's 1965 book of identical title, *A Short History of Chemistry* (263 pages), was originally issued as an inexpensive paperback as part of Doubleday's Science Study Series. While it is certainly the most accessible account for the layman, it has no references and appears to have been based solely on secondary sources and encyclopedia articles. These problems, coupled with the fact that it is now only available as an expensive hardcover reproduction, largely preclude its use as a text in a serious history of chemistry course.

Perhaps the most iconoclastic history currently in print is Cecil Schneer's 1969 volume, *Mind and Matter* (305 pages). While primarily a history of chemistry, it attempts, as its title suggests, to inject sizable doses of the history of physics and materials science. Though at first glance this integration appears desirable, it actually produces a distortion of the history of chemistry itself. Thus, for example, the history of chemical thermodynamics, as developed by chemists, followed a very different path from the development of thermodynamics in physics, which is the version given by Schneer.

Despite this abundance of choices, the perceptive reader will have noticed that even the most recent of these volumes is now over 20 years old. As a result, historians have increasingly felt the need for a new history of chemistry that will not only cover the history of the last half century but also effectively integrate the new interpretations of the older periods developed

by historians since the 1960s. It is thus with high expectations that one approaches this new history of chemistry, *From Caveman to Chemist*, by Hugh W. Salzberg, and just as quickly comes away disappointed. The problem is not that what Salzberg has written is particularly incorrect but rather why he has bothered to write it in the first place.

The book contains no new interpretive insights - a not surprising defect given that the author appears to have read little of the recent literature in the history of chemistry. It is not a contribution to original scholarship - no new information is uncovered, no new periods are evaluated. Though the author lists the titles of a few original chemical papers in his references, his direct quotes from these papers are taken second-hand from earlier histories of chemistry and one strongly suspects he has never examined most of the primary chemical literature whose content and importance he purports to explain.

The book does not update earlier histories. If anything, it is a step backwards since Salzberg terminates his coverage at 1900. Even then, over half the book deals with ancient technology and alchemy and Salzberg's treatment of 19th century chemistry is little more than a sketchy afterthought which completely ignores the development of chemical thermodynamics and kinetics.

The book does not address a new audience. The earlier accounts by Partington, Leicester, Asimov and Schneer are just as brief and just as accessible to the layman (and all are more thorough in their coverage).

One cannot even compliment the book on its illustrations. Ignoring the large collections of chemical portraits and prints available at the Universities of Pennsylvania, Wisconsin and Cincinnati, the 20 rather murky illustrations in the book were obtained mostly from the Bettmann Archives. None of the captions indicate the original books from which these illustrations were taken and the drawing of Hale's original pneumatic trough on page 189 has been altered by an unknown artist and printed backwards. The book contains no portraits of famous chemists, despite the explicitly biographical approach used in many sections and, though large portions of the book are devoted to alchemy, few of the illustrations reflect its rich symbolic and pictorial literature.

In short, whatever criterion is used, there is a history of chemistry currently in print which does the job much better and one is left wondering why this book was ever published. And, unhappily, one is also left with the unanswered question of how to write a history of chemistry that will effectively incorporate recent historical research on pre-20th century chemistry while simultaneously providing an integrated overview of the last 90 years, not to mention the question of who is best qualified to write such a history (chemist or historian or a team of both). The only thing that is certain is that *From Caveman to Chemist* is regrettably, but most emphatically, not the answer. William B. Jensen, Department of Chemistry, University of Cincinnati, Cincinnati, OH 45221

Robert Robinson: Chemist Extraordinary, Trevor I. Williams, Clarendon, Oxford, 1990. 201 pp. Cloth (Typeset). \$49.95.

As a chronicle of Robert Robinson's rise from middle-class provinciality (his mother was one of the Cheshire Davenports) to the 1947 Nobel Prize for Chemistry and the Presidency of the Royal Society of London, this pedestrian and, at times, repetitive book just passes muster. As an analysis of what it was that made Robinson an extraordinary chemist, it must be accounted absent-on-parade. In fairness, the author denies any such obligation:

In particular ... they [Lord Todd and Sir John Cornforth] lay more emphasis on his professional achievements than on his personal life. Because of this gap in the literature, I was responsive to a wish of Dr. Marion Way, Robinson's daughter, to write an extended biography of her father.

In short, this is an authorized biography with all of the warts and most of the chemistry omitted. For whom is such a book intended? As Abraham Pais has admirably shown, even a phenomenon such as Einstein deserves a biography that squarely faces his immortalizing science.

In spite of his genuine contributions to the early development of physical organic chemistry, Robinson represents the end of an old tradition rather than the beginning of a new one. He came to maturity when the gray eminences of Oxford and Cambridge used Colonial, Scottish, and the lesser English universities as components of an involuntary academic farm system. In rapid succession, Robinson held chairs in Sydney, Liverpool, Saint Andrews, and London before succeeding his mentor, W. H. Perkin, Jr., at Oxford in 1930. Like Perkin, Robinson's genius lay in natural product chemistry: structural determinations followed by larger-scale, short-sequenced synthesis. Williams notes Robinson's uneasiness when availability dictated a micro-scale approach to the structural work on penicillin. Strangely, Williams does not discuss Robinson's synthetic approach to the steroidal ring system. Robinson was an avid mountaineer and his methods seem more analogous to the knickerbockered gallantry of Mallory and Irvine than the nylon-clad laying-siege-to-the-mountain approach of R. B. Woodward. In spite of the 30-year age difference, there was much respect between the two and there is an agreeable historical resonance in that Woodward joined Robinson as founding co-editor of *Tetrahedron*.

As a former student of Hughes and Ingold, the reviewer turned eagerly to Chapter 7, "The Electronic Theory of Reaction: the Ingold Controversy". Even the title sounds slightly off-key and the ensuing discussion is equally unsatisfactory. In his lectures to undergraduates, which had a substantial historical component, Ingold gave scant recognition to Robinson (though rather more to Lapworth and Lowry) even though Robinson was earlier in the field and up to about 1930 had

contributed as much mechanistic insight. Unlike Ingold, however, “[Robinson] had little feeling for physical chemistry”. With Hughes’ help, Ingold quickly seized on kinetics as the key to reaction mechanism. Later he was to embrace spectroscopy, radioactive labelling, transition state theory and *ad hoc* quantum mechanics. Strangely, it was a Robinson student, M. J. S. Dewar, who was to pioneer in the application of molecular orbital theory to physical organic chemistry. Ingold had a highly ratiocinative mind and his landmark 1934 article in *Chemical Reviews* reads like a legal brief as to how God should have fashioned physical organic chemistry if only He had listened to the best advice. In spite of its aridity, the 60-year old review holds up remarkably well. By contrast, Robinson’s two 1932 publications and even the 1947 Faraday Lecture are historical relics. Of the latter Williams writes:

... though basically a lucid exposition, its old fashioned terminology must at points have baffled some of the younger members of the audience.

During that lecture, a much younger version of the present reviewer was sitting across the aisle from Ingold. As Robinson floundered on, a thin Gioconda smile became permanently fixed on Ingold’s face. Robinson never gave up on his claims and even after Ingold’s death, he could write “the development of these ideas constituted, in the writer’s opinion, his most important contribution to knowledge”. Today few would agree with this self-assessment, but there is no doubt that in this regard history (and Ingold) treated him a trifle scurvily. Perhaps some redress can be made when the Division of History of Chemistry sponsors a symposium on the early history of physical organic chemistry at the 1993 Fall ACS meeting in Chicago - a symposium prompted by the centenary of Ingold’s birth!

After more than 500 years of practice, one would have expected the Clarendon Press to honor one of its own with fewer proof-reading errors and with better structural formulas than those found on page 74. *Derek A. Davenport, Department of Chemistry, Purdue University, West Lafayette, IN 47907*

Michael Faraday and the Royal Institution: the Genius of Man and Place, John M. Thomas, Hilger, Bristol, 1991. xii + 234 pp. Paper (Typeset). £12.50. *Selections and Reflections: The Legacy of Sir Lawrence Bragg*, John M. Thomas and Sir David Phillips (Editors), Science Reviews, Ltd, Northwood, Middlesex, 1990. 308 pp. Cloth (Typeset). \$57.00.

In these two very different books, Sir John Thomas, the Fullerian Professor of Chemistry at the Royal Institution in London, pays tribute to two of his illustrious predecessors. Their common benefactor, John Fuller, “lounged in Faraday’s lectures in an old-fashioned blue coat and brass buttons, grey

smalls and white stockings”. Of him, it was said that:

... the feebleness of whose constitution denied him at all other times and places the rest necessary for health could always find repose and even quiet slumber amid the murmuring lectures of the Royal Institution and that in gratitude for the peaceful hours thus snatched from an otherwise restless life bequeathed to the Royal Institution the magnificent sum of £10,000.

Such indolence is clearly not permitted to his beneficiaries. With the bicentennial of Faraday’s birth and the sesquicentennial of The Royal Society of Chemistry, Sir John has yet found time to pay superb tribute to both Michael Faraday and Sir Lawrence Bragg.

The Faraday book shares much of the grace and insight of John Tyndall’s *Faraday as a Discoverer* while benefitting from the historical perspective of a further 120 years. While Faraday remains the central figure, the results for the forces he and Davy set in motion are admirably delineated. As the title correctly implies, The Royal Institution is as much the hero of Thomas’ story as is Michael Faraday himself. The book is generously and imaginatively illustrated and is directed to the general reader “especially young people in the arts and in all branches of the sciences who are about to enter tertiary education”. Faraday would surely have approved.

As benefits one of Silurian ancestry, Thomas writes with eloquence and grace:

Part of the magic of Faraday’s writing is that it elicits admiration and conveys information in equal measure ... He tells of his failures as well as his successes, so that the reader is tempted to believe that if he had access to a laboratory, he too might become a discoverer and be admitted to the privileged circle of those who have enlarged the bounds of human knowledge. Reading his work, one senses an unique amalgam of compelling immediacy and Chekovian timelessness, mingled with an abundance of optimism (even elation), self-control and self-criticism. There is no hunger after popular applause, no jealousy of the work of others, no deviation from his self-imposed practice of “working, finishing, publishing”. His versatility, originality and stamina leave us in awe.

Later, having given an impressive list of immortals who have graced the large lecture room in Albermarle Street, Thomas slyly continues, “Proceeding to the second letter of the alphabet, we note that ...” The reader then realizes that only those whose names began with the letter “A” have been cited so far. As one who has assumed Faraday’s mantle, though no doubt with a certain amount of trepidation, Thomas is unique amongst recent biographers in having intimate knowledge of the day-to-day workings of the Royal Institution. His discussion of the management of the Evening Discourses and of the Christmas Lectures for a “juvenile auditory” are fascinating, though Faraday’s daunting statement that “A truly popular

lecture cannot teach, and a lecture that truly teaches cannot be popular” comes as something of a shock. The Royal Institution has been blessed in its history and in its servants. It has also been blessed in those who have chronicled that history and those people. The present small volume is an admirable addition to the canon.

The second book is of a totally different character, primarily intended for those who know something of the younger Bragg's life and achievement. Approximately one half of the book is devoted to Sir David Phillip's official yet graceful obituary reprinted from the *Biographical Memoirs of the Fellows of the Royal Society* and to short personal reminiscences of Bragg by a veritable galaxy of illuminati, including ten Nobel Laureates. The remaining half of the book contains a selection of Bragg's writings ranging from the seminal papers on X-ray crystallography to *The Art of Talking About Science*. At the age of 25, Lawrence Bragg shared the 1915 Nobel Prize for Chemistry with his father. More than 50 years of active scientific life were yet to come. It is a tribute to Bragg's genius that he lived them to such good and generous effect. Having been present at the creation of X-ray crystallography, he fostered its growth and was to live to see the triumphs of molecular biology. Along the way, he contributed many of the advances in structure determination that made those triumphs possible. Equally importantly, as Cavendish Professor of Experimental Physics at Cambridge, he used his influence to nurse Perutz and Kendrew through their locust years and his patience to tolerate Watson and Crick in their salad days. All four contribute character tributes.

In his book on Faraday, Thomas describes the Royal Institution as “the foremost repertory theatre for the popularization of science in the world”. In his later years, Lawrence Bragg was to devote much of his time to the popularization of science, particularly, via radio and TV, for school audiences. For this he was sometimes patronized by his more collimated colleagues. But to inherit the popularization-of-science torch from Davy, Faraday, Tyndall, Dewar, and William Bragg, to run with it to such good effect, and to hand it on to a George Porter and a John Thomas, is an enviable achievement. This is an admirable book about a most admirable and likeable man.
Derek A. Davenport, Department of Chemistry, Purdue University, West Lafayette, IN 47907

Wissenschaftliches Jahrbuch 1990, Deutsches Museum, Munich, 1990. 154 pp. Cloth (Typeset). DM 48.

The Deutsches Museum, familiar to most tourists to Munich, is arguably the finest science and technology museum in the world. What few visitors notice, and even fewer have occasion to enter, is the imposing Bibliotheksbau across the courtyard from the Museum's main entrance. Within this structure is Germany's finest dedicated collection of printed and archival

materials related to the history of science and technology. Several scholarly institutes are also housed there, where much excellent historical research is carried out.

Readers seeking a sampling of this research can do no better than to pick up the present volume. We have here seven essays written by scholars connected with the Museum or its associated institutes, covering subjects ranging from ancient water clocks to Sommerfeld's role in the origin of solid state physics. Other topics include William Thomson, Werner von Siemens and the gyrocompass; the story surrounding a six-ton lead sphere with the help of which Philipp von Jolly measured the density of the earth; the history of the Deutsches Museum itself; and J. H. Mädler's 19th-century maps of the moon's surface. Of the greatest interest to historians of chemistry in particular is Elisabeth Vaupel's intriguing paper on the rise and fall of the 19th-century Sicilian sulfur industry, which explores various political, technical and economic implications of the story.

This is the second such yearbook produced by the Museum, and we look forward to a continuation of the series. One worries, however, about fine papers being lost in volumes such as this whose contents are too miscellaneous; the editors might be well advised in future to follow the model of the revived journal *Osiris*, whose annual issues are usually organized under such topical rubrics as “Historical Writing on American Science” or “The Chemical Revolution”.

This small book is nicely produced in glossy paper and is richly illustrated. It may be obtained from the Museumsladen des Deutschen Museums, Museumsinsel 1, D-8 München 22.
Alan J. Rocke, History of Science and Technology Program, Case Western Reserve University, Cleveland, OH 44106

Das Tagebuch des Erzherzogs Leopold, Josef Vozár (Editor), Osveta Publishing House, Marin, Czechoslovakia, 1990. 192 pp. Cloth (Typeset and Photoreproduction). 20 Czech Crowns.

The English translation of the title of this book would be “The Diary of Archduke Leopold”. Prince Leopold (1747-1792) was the youngest son of Empress Maria Theresa (1717-1780) of Austria. His mother sent him with his older brother, Crown Prince Joseph (1741-1790), to tour the mining district of Schemnitz-Kremnitz-Neusohl in Upper Hungary (part of the Austrian Empire - now the Slovak Republic). These are the German names of the towns known today by their Slovakian names of Banska Stiavnica, Kremnica and Banska Bystrica, respectively.

The visit took place from 19-31 July 1764. The two princes were accompanied by a group of court officials and specialists. Leopold, who was 17 years old at the time, took notes during his visit and made sketches of what he saw in a travel diary. He eventually became Leopold II, Emperor of Austria and King of Hungary, upon the death of his older brother, Joseph II, in

1790. When he also died, two years later, he was succeeded to the throne of Hungary by his son, Franz II (1768-1835), whose daughter, Marie Louise (1791-1847), was to marry Napoleon Bonaparte in 1810.

The diary was discovered by Professor Josef Vozár of the Slovak Academy of Science in Bratislava while visiting the Austrian National Library in Vienna and the published version contains both the original text of the diary and a Slovak translation. Printed on a high-quality paper, it contains numerous important historical remarks by Dr. Vozár. The editor had to solve numerous difficulties in order to produce such an excellent book. For example, the handwritten journal was not always clear and the paper used by Leopold was not of high quality; writings from the back side of pages sometimes were visible on the front side and confused the reader; the ink in some places was washed away with water; the Prince used many abbreviations which were difficult to resolve; and he gave dimensions of equipment without identifying the units, etc. However, Leopold made many useful sketches of the machines, tools, and technical installations and described the social life and jobs of the miners of that time.

The diary is divided into four parts:

* Part 1: "Diary of Our Trip to the Mines of Hungary in the Year of 1764 in the Month of July", consisting of 57 pages written in French by an unknown author. As implied by the title, this has the character of a diary and contains the names of the participants, those who received the Prince in Schemnitz, and an itinerary of the trip.

* Part 2: "Some Remarks on the Work in the Mines" consisting of 21 pages written in German and containing remarks on the operation of the mines, their importance, problems of mine water, salaries of miners, and the blasting of rocks. The first attempt to use gunpowder as an explosive to break rocks in mines was conducted on 27 February 1627 in Schemnitz. The practice spread to other mines in the Austrian Empire; then in 1635 to the Harz Mountains in Germany; in 1643 to Freiberg; in 1650 to the Rhine region; and in 1670 to England. This section also categorizes the miners (who totaled around 6,000) and describes their various jobs.

* Part 3, consisting of 24 pages written in German, and giving a description of the mines themselves, the transport of ores, the people in the mines, and the removal of mine water. This, together with Part 2, can be considered as a small encyclopedia on 18th-century mining.

* Part 4, consisting of 13 pages written in German, giving a short description of the mines, the main machines, and the mining statistics for Schemnitz, Kremnitz and Neusohl. It also enumerates the profits of the Emperor and those of the labor union.

The book is a welcome addition to the mining and metallurgical library, and an English translation would be desirable. Fathi Habashi, Department of Mining & Metallurgy, Laval University, Quebec City, Canada G1K 7P4

The American Synthetic Rubber Research Program, Peter J. T. Morris, University of Pennsylvania Press, Philadelphia, PA, 1989. 203 pp. Cloth (Typeset). \$34.95.

The U.S. Government began a comprehensive program of synthetic rubber research in 1942 to compensate for the wartime loss of natural rubber supplies and continued the strategy for a decade after World War II was over because of concerns related to the Cold War. This program represented a major attempt to develop cooperation among government, industry, and university laboratories, and so is of special interest not only to historians of science, but also to policy makers concerned with government support of research and industrial development.

There is still considerable disagreement on the key question of whether or not the rubber research project was successful. Those involved are very enthusiastic, but more recent analyses have questioned its usefulness. This is not just a historical issue, since the rubber program was used as a model for President Carter's energy program and may offer justification for similar government-sponsored efforts to support U.S. industries.

The breadth and depth of Morris' research are impressive. His many references include a wealth of primary resources, commentaries on the program, and interviews with many major participants. Based on this broad perspective, Morris concludes that the project achieved its goals during World War II, but the attempt to continue the work following the war was not as successful. He offers a variety of reasons for this diminished productivity, including failure to identify clear goals, lack of strong leadership, and inconsistent support from Washington.

A closely related question is whether there was effective interaction between industrial and academic laboratories. The author suggests that, although university-based researchers did make some valuable contributions, many of the problems cited above were also present here. Academic research did develop new fundamental information and make possible incremental improvements in the process, but it didn't produce radical innovations. In part, then, evaluating the success of this aspect of the project is related to the relative importance one places on incremental in opposition to radical changes.

Morris concludes that the best way to promote radical technological innovation in peacetime is commercial competition rather than government-sponsored efforts to demand cooperation. One of his most interesting asides points out that if this is true, the result of industrial mergers may be reduced competition and, therefore, fewer major innovations by U.S. companies.

The new series on *The Chemical Sciences in Society* is intended to present the best scholarship dealing with the importance to society of the chemical sciences. Peter Morris not only does a thorough analysis of an important technologi-

cal development, but also offers some valuable advice for current policy makers. His book is an excellent beginning for this new series. *Harry E. Pence, Chemistry Department, SUNY-Oneonta, Oneonta, NY 13810.*

Steroids Made It Possible, Carl Djerassi, American Chemical Society, Washington, D. C., 1990. xxiv + 205 pp. Cloth (Typeset), \$24.95.

How many interesting, articulate individuals have written intriguing autobiographies? Carl Djerassi has succeeded in accomplishing this goal with gusto. As a person who has straddled a variety of careers and environments, Djerassi has much to say about the so-called "Golden Age" of organic chemistry. The breadth of his interests and his achievements have allowed him to produce lasting work in pure academic science, to be involved in flourishing industrial ventures, and to have carried out projects which have had significant social impact.

Arriving in the United States from Europe in his teens, shortly before the outbreak of World War II, Djerassi rapidly completed his formal education. He then became involved with industrial research in medicinal chemistry; was instrumental in the establishment of several major chemical corporations, including Syntex and Zoecon; produced more than 1000 refereed articles, with the majority focusing on various aspects of steroid chemistry; published several well-received books; and taught generations of undergraduate and graduate students while serving on the faculties of several prestigious universities. Carl Djerassi has had an enormous leadership influence on the development of the post-World War II pharmaceutical enterprise in this county. He has also become a major spokesperson for the balanced importance of both science and art in contemporary culture. Part serious scientist, part striving artist, part social critic, and part reflective teacher, this man far transcends the Ivory Tower.

Perhaps the first prerequisite for the multi-faceted accomplishments so characteristic of Djerassi was the juxtaposition of both intelligence and ego. In characteristic fashion, he often attempted activities for which the outcome might have been embarrassing failure. Instead, his combination of basic talent, courage, and persistence led, in remarkably consistent fashion, to highly favorable progress.

Constructing this book on several levels, the author has managed to weave together many aspects of his personal life alongside a running commentary on his scientific endeavors. Given the sheer volume of Djerassi's journal publications, his autobiography, by providing a historical review of his research interests, goes a long way toward orienting and redirecting the reader back to the body of his published science. One might conclude that there may actually be something of a disadvantage for a scientist to have so many publications, since many

readers will be somewhat distracted from seeing the main themes. To miss the forest for the trees would be particularly sad given Djerassi's significant and imaginative work in organic chemistry. In many respects, this book is an atlas of that work with no apologies for its sophisticated chemical specialization, but also written in a crisp and interesting style that holds the casual reader's interest by its many asides into the associated players who were important in Djerassi's intellectual adventures.

Djerassi's recognition that steroids could provide a platform for numerous scientific investigations was deeply perceptive. Entering a subdiscipline of chemistry that already had many skilled experimentalists, Djerassi strove to emerge as a broadly-based generalist who utilized steroids for fundamental studies in such areas as spectroscopy, medicinal chemistry, synthetic methodology, and biosynthesis. Inevitably, the natural outcome of this approach was for him and his group of colleagues to become "lightning rods" for the whole field.

Djerassi's wide-ranging curiosity led repeatedly to excellent science. Thus, considering just one area he explored, using available natural products as a practical backdrop, his seminal studies on spectroscopy yielded hundreds of papers running the gamut from the background tabulations needed to establish fundamental principles (e.g., the octant rule) to publications that probed how artificial intelligence might be applied to the vast amounts of data generated by modern spectroscopic techniques. His insight that artificial intelligence might allow virtually automated structure elucidation was a daring concept when he first began yet it has all but been accomplished today.

Djerassi also recognized the enormous social implications of organic chemistry. He has lectured and written extensively on the impact of safe, reliable contraception on the emancipation of women from stereotypical role-playing and all that implied for the liberation of our species. As an outgrowth of his interest in mammalian contraception, he also became intrigued by the necessity to limit the population of harmful insects but to do so in an environmentally unthreatening way. As a result of his interactions with individuals and institutions in the Third World, he was led to make real efforts at strengthening the scientific infrastructure of these areas so that their further technological and economic development might be assured.

What comes across in his autobiography is an image of Carl Djerassi as an extremely complex, creative individual with both strengths and weaknesses. He is a very special breed of intellectual. In many respects, Djerassi appears to be an archetype of the "Scientist as Artist", a 20th century Renaissance Man in his restless quest for new frontiers to conquer. Through his writing, Djerassi illustrates how a charismatic individual can create a personal dynamic that arguably stimulated those who worked closely with him to accomplish much more than they might have thought possible. Perhaps another valid description for Djerassi also consistent with his autobiog-

raphy is "Scientist as Catalyst".

At the close of his book, Djerassi confides to us how he believes that his life is about to undergo a phoenix-like rebirth wherein he will conclude his activities in the laboratory and now embark on a very strong artistic focus with special emphasis on serious literary works. One senses that he may be an almost unique individual able to bridge C. P. Snow's two cultures. Already, his first major effort in this direction, the novel *Cantor's Dilemma*, has attracted critical acclaim, with more novels in the works.

In this reviewer's opinion, by taking serious risks involving candor and self-expression (in a way that mirrors his own life history), Djerassi has managed to write an intensely personal document that not only describes his own career, but also manages to orient the reader toward the significant struggles that have gone on at the interface between organic chemistry and society at large. In effect, this book provides thought-provoking reading for contemporary scientists who are troubled with the controversial image that so much of society has of the chemical enterprise. *John Belletire, Department of Chemistry, University of Cincinnati, Cincinnati, OH 45221.*

LETTERS

The Mines of Schwaz

Readers of the review of the *Schwazer Bergbuch* (Issue 8, Winter 1990) may like to know that the old mine workings at Schwaz can be visited. Silver was mined there for about 500 years, until 1900, and several of the many kilometers of galleries inside the mountain are accessible to the public in complete safety. The entrance is just above Schwaz, about 35 kilometers east of Innsbruck in the valley of the River Inn, and as the route is itself attractive and Schwaz has some fine old buildings, a visit makes a good excursion by car or bus for anyone on holiday in that part of Austria. The *Silberbergwerk* is open from 9 am to 5 pm every day except from 1 November to 26 December each year, and there are frequent guided tours, for a small charge, lasting about an hour.

William A. Smeaton, University of London

The Nascent State

The article on the nascent state (Issue 6, Spring 1990, pp. 26-36) cited Priestley in 1790 as an early user of the term, antedating an *Oxford English Dictionary* citation for Kirwan of 1796. I have often wondered if the term was not part and parcel of phlogistic doctrine; both Priestley and Kirwan were phlogistonists and I have the impression that the theory was much involved (in ways that are hard for me to understand) with ideas of birth and death. I have never checked Becher or

Stahl to discover if they, perhaps, worried about "nascent" (*freiwerdend*) materials. I have also been struck with how often the term "nascent" appeared in areas other than natural philosophy in 18th century England. Perhaps one reason it caught on so firmly in chemical literature was because the same term found such frequent use in general speech. Readers might also be interested to know that Davy first discussed the ability of the voltaic pile to generate "nascent" hydrogen in 1800:

If the ratio between the quantities of the oxygen and the hydrogen produced from different wires be always the same, whatever substances are held in solution by the water connected with them, this nascent hydrogen will become a powerful and accurate instrument of analysis (*Nicholson J.*, 1800, 4, 281).

June Z. Fullmer, Ohio State University

FROM THE CHAIR

Conventional wisdom has it that scientists seldom show an interest in the history of science until their active research careers are over and then only because they are interested in securing a place for themselves in the historical record. Were this really true, one would expect that histories of chemistry would be written only by chemists in their 60s and 70s and that the Division of the History of Chemistry would be largely populated by retirees. As Colin Russell has recently shown (*Brit. J. Hist. Sci.*, 1988, 21, 3-13), the first of these premises is definitely false and, in fact, many of the outstanding histories of chemistry written in the 19th century were authored by chemists at the beginning, rather than the end, of their active research careers. Similarly, the results of a recent demographic study by the ACS fail to show any preponderance of sexa- and septuagenarians in the Division. Indeed, the age profile is about what one would expect for any group of scientists, with a maximum for chemists in their 40s and 50s and smaller numbers as one moves toward both younger and older age brackets. About 14% of the Division is between the ages of 21-30, 17.2% between the ages of 31-40, 19.4% between the ages of 41-50, 20.9% between the ages of 51-60, 14.9% between the ages of 61-70, and 9.8% above 70 (these figures do not total to 100% because not everyone reported this information). The data also show that 23.3%, or nearly a quarter, of the Division has joined since 1986, reflecting our rapid growth in recent years, spurred in part by the decision to begin publication of the *Bulletin*.

Other statistics are less surprising. 81.5% of the Division is male, reflecting the general preponderance of males in all fields of chemistry; 91.1% of the Division is domestic; 52.6% hold doctoral degrees in chemistry, with 82.2% holding chemical degrees of some sort. The single largest occupational group in the Division is university and college teachers,

with a share of 27.3%, followed by chemists engaged in applied industrial research, with a very weak second of 6.0%. Likewise, the largest percentage (18.2%) of the Division listed their primary area of concentration as chemical education, followed by organic chemistry at 13.7%.

The age profiles and growth statistics are pleasant surprises and the verification that our primary audience consists of teachers of chemistry, as we suspected all along, is a satisfying confirmation that both the Division's current policies in programming and the format of the *Bulletin* are correctly targeted.

William B. Jensen, 1991 HIST Chair

EVENTS OF INTEREST

* The Eastern Analytical Symposium is planning a special session at its November 1992 meeting entitled "Christopher Columbus Celebration: Serendipitous Discoveries in Chemistry and Spectroscopy." For further information, potential contributors should contact EAS Program Committee, P.O. Box 633, Montchanin, DE 19710-0633.

* The July/August 1990 issue of the *Chemiker-Zeitung* carries an article on pages 244-246 by G. Dannhardt and M. Lehr on "Antiphlogistische 2,3-Dihydro-1H-Pyrrolizine". Your editor was quite interested to note that the debate over Lavoisier's system was apparently still in full swing in East Germany until he realized that the term was being used in its literal sense and that the compound in question was a potential anti-inflammation drug.

* Travel grants are available from the Beckman Center for the History of Chemistry to enable interested individuals to visit Philadelphia to make use of the Othmer Library, the Edgar Fahs Smith Collection, and other associated facilities. The grants, which may be used for travel, subsistence, and copying costs, will not normally exceed \$500. Applications should include a vita, a one-paragraph statement on the research proposed, a budget, and the addresses and telephone numbers of two references. Deadlines are 1 February for grants covering the period April-June, 1 May for July-September, 1 August for the period October-December, and 1 November for the period January-March. Send applications to Lisa Kazanjian, Beckman Center for the History of Chemistry, 3401 Walnut Street, Philadelphia, PA 19104-6228, (215) 898-4896.

* The Oesper Collection in the History of Chemistry of the University of Cincinnati is looking for donations of old chemistry texts, photographs, prints, molecular models, and chemical apparatus to add to its collections. Interested parties should contact Dr. William B. Jensen, The Oesper Collection in the History of Chemistry, Department of Chemistry, ML 172, University of Cincinnati, Cincinnati, OH 45221.

FUTURE MEETINGS

San Francisco 5-10 April 1992

Five copies of 150-word abstract (original on ACS Abstract Form) by 1 December 1991. Title of paper by 1 November 1991.

* *General Papers*. Contact J. L. Sturchio, Corporate Archives, Merck & Co., Inc., P.O. Box 2000, Rahway, NJ 07065-0900, (908) 594-3981, FAX (908) 594-3977.

* *Bay Area Biotechnology: History As It Happens*. Contact H. Lowood, History of Science & Technologies Collections, Stanford University Libraries, Stanford University, Stanford, CA 94066, (415) 723-4602 or J. L. Sturchio (see address above).

* *The Role of Chemistry and Materials in the Rise of Silicon Valley*. Contact H. Lowood, History of Science & Technologies Collections, Stanford University Libraries, Stanford University, Stanford, CA 94066, (415) 723-4602 or J. L. Sturchio (see address above).

* *Chemical Genealogy*. Contact P. R. Jones, Department of Chemistry, University of New Hampshire, Durham, NH 03824, (603) 862-1550.

* *The Role of Chemistry in Science Fiction*. Contact J. H. Stocker, Department of Chemistry, University of New Orleans, New Orleans, LA 70148, (504) 286-6852.

Geneva 22-24 April 1992

* *100th Anniversary of the Geneva Conference*. Organized by J. G. Traynham, Department of Chemistry, Louisiana State University, Baton Rouge, LA 70803, (504) 388-3459.

Washington DC ... 23-28 August 1992

Five copies of 150-word abstract (original on ACS Abstract Form) by 15 April 1992. Title of paper by 1 April 1992.

* *General Papers*. Contact M. D. Saltzman, Department of Chemistry, Providence College, Providence, RI 02918, (401) 865-2298.

Denver ... 28 March - 2 April 1993

Five copies of 150-word abstract (original on ACS Abstract Form) by 1 December 1992. Title of paper by 1 November 1992.

* *General Papers*. Contact M. D. Saltzman (see address above).

Chicago 22-27 August 1993

Five copies of 150-word abstract (original on ACS Abstract Form) by 15 April 1993. Title of paper by 1 April 1993.

* *General Papers.* Contact M. D. Saltzman (see address above).

* *C. K. Ingold, 1893-1970. Master and Mandarin of Physical Organic Chemistry.* Contact M. D. Saltzman, Department of Chemistry, Providence College, Providence, RI 02918, (401) 865-2298, or Derek Davenport, Department of Chemistry, Purdue University, West Lafayette, IN 47907, (317) 494-5465.

Tentative Future Symposia

(Please contact M. D. Saltzman if you are interested in organizing or participating in the following.)

- * *Chemistry and Communications*
- * *History of Chemical Processes in Industry*
- * *Case Histories of Drug Discovery and Development*

1992 OFFICERS DIRECTORY

* *Chair:* Ben B. Chastain, Department of Chemistry, Samford

University, Birmingham, AL 35229-0002, (205) 870-2725.

* *Chair-Elect:* Jeffrey L. Sturchio, Corporate Archives, Merck & Co., Inc., P.O. Box 2000, Rahway, NJ 07065-0900, (908) 594-3981; FAX (908) 594-3977.

* *Past-Chair:* William B. Jensen, Department of Chemistry, University of Cincinnati, Cincinnati, OH 45221-0172, (513) 556-9308.

* *Secretary-Treasurer:* Harold Goldwhite, Department of Chemistry, California State University, Los Angeles, CA 90032-4202, (213) 343-2300.

* *Program Chair:* Martin D. Saltzman, Department of Chemistry, Providence College, Providence, RI 02918-0001, (401) 865-2298.

* *Councilor:* Mary Virginia Orna, Department of Chemistry, College of New Rochelle, New Rochelle, NY 10801, (914) 654-5302.

* *Alternate Councilor:* Leon Gortler, Department of Chemistry, Brooklyn College, Brooklyn, NY 11210-2889, (718) 780-5746.

* *Chair, Archeology Subdivision:* Ralph O. Allen Jr., Department of Chemistry, University of Virginia, Charlottesville, VA 22901, (804) 973-7610.

* *BCHOC Representative:* James J. Bohning, Beckman Center for the History of Chemistry, 3401 Walnut Street, Philadelphia, PA 19104-6228, (215) 898-1302.

COMING IN MARCH OUR SPECIAL FARADAY ISSUE

- | | |
|---|--|
| * "Symposium Introduction"
<i>by Derek A. Davenport</i> | * "Faraday's Health Problems"
<i>by James F. O'Brien</i> |
| * "The Royal Institution and Michael Faraday:
A Personal View" <i>by John M. Thomas</i> | * "Faraday's 1822 'Chemical Hints' Notebook and the
Semantics of Chemical Discourse" <i>by Ryan D. Tweney</i> |
| * "Faraday and his Biographers"
<i>by L. Pearce Williams</i> | * "Whiggish Observations on Faraday as Organic
Chemist Manqué", <i>by Derek A. Davenport</i> |
| * "Educating the Judgement: Faraday as Lecturer"
<i>by Geoffrey Cantor</i> | * "Michael Faraday and the Art and Science of Chemical
Manipulation" <i>by William B. Jensen</i> |
| * "Faraday's Election to the Royal Society: A Reputation
in Jeopardy" <i>by June Z. Fullmer and Mel Usselman</i> | * "The Chemical Manipulator"
<i>by Sidney Ross</i> |
| * "The Military Context of Chemistry: The Case of
Michael Faraday" <i>by Frank A. J. L. James</i> | * "Faraday's Search for Fluorine"
<i>by Harold Goldwhite</i> |
| * "Michael Faraday's Bibles as Mirrors of His Faith"
<i>by Herbert T. Pratt</i> | * "The Pathway to the Laws of Electrolysis"
<i>by John T. Stock</i> |
| * "Unpublished Letters of Faraday and Others to
Daniel Clarke" <i>by Sidney Ross</i> | * "From Electrochemical Equivalency to a Mole of
Electrons: The Evolution of the Faraday"
<i>by Marcy Hamby Towns and Derek A. Davenport</i> |

BULLETIN FOR THE HISTORY OF CHEMISTRY

Subscription and Membership Application

- _____ ACS Member at \$10.00/year (includes full divisional membership)
_____ Non-ACS Member at \$12.00/year (includes affiliate divisional membership)
_____ Library Subscription (\$15.00/year)

Begin subscription with the year 19 _____

Name _____

Address _____

Signature _____

Return to Dr. William B. Jensen, Editor, *Bulletin for the History of Chemistry*, Department of Chemistry, ML 172, University of Cincinnati, Cincinnati, OH 45221. Checks should be made payable to the Division of the History of Chemistry, ACS.

University of Cincinnati
BULLETIN FOR THE HISTORY OF CHEMISTRY
William B. Jensen, Editor
Department of Chemistry
University of Cincinnati, M. L. 172
Cincinnati, OH 45221

Non-Profit Org.
U. S. Postage
PAID
Cincinnati, OH
Permit No. 133

UNIVERSITY OF CINCINNATI
DEPARTMENT OF CHEMISTRY
M. L. 172
CINCINNATI, OH 45221